

COMPETENCE B8920-1

Built In Fan / Steam Oven

Installation and Operating Instructions

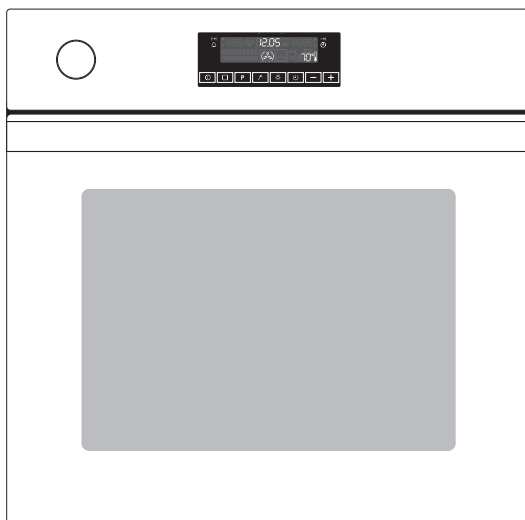

Dear Customer,

Please read this instruction book carefully.
Above all, please observe the "safety" section on the first few pages.
Please retain this instruction book for later reference. Pass them on to any subsequent owners of the appliance.

The following symbols are used in the text:



Safety Instructions

Warning: Information concerning your personal safety.

Important: Information on how to avoid damaging the appliance.



Information and practical tips



Environmental information

1. These numbers indicate step by step how to use the appliance.
2. ...
3. ...

These operating instructions contain information on steps you can take yourself to rectify a possible malfunction. Refer to the section "What to do if...".

Your local AEG Service Force Centre is available to deal with technical problems (addresses and telephone numbers are listed under "Customer Service Centres").

For additional information, also see the section "Service & Spare Parts".

Printed on recycled paper.

Thinking ecologically means acting ecologically ...

Contents

Operating Instructions	5
Safety	5
Disposal	6
Description of the Appliance	7
General Overview.....	7
Control Panel	8
Oven Features.....	8
Oven Accessories	9
Before using for the first time	10
Setting the clock	10
Setting the Language	11
Setting the Display Brightness	12
Initial Cleaning.....	13
Operating the Oven	14
The Electronic Oven Control.....	14
Oven Functions.....	15
Switching the Oven On and Off.....	17
Inserting the general purpose pan, grill, and tray	20
Inserting/Removing the Grease Filter	20
Steam Cooking Functions.....	21
Additional Functions.....	23
Clock Functions	26
Other Functions	32
Switching off the clock display	32
Child Safety Device	33
Button Lock.....	34
Oven Safety Cut-out	34
Usage, Tables and Tips	35
Steam Cooking.....	35
Vigorous Steam	36
Vigorous Steam Table.....	36
Vigorous Steam and Fan Cooking in succession	37
Vigorous Steam and Fan Cooking in succession	37
Interval Steam	38
Interval Steam Cooking Table.....	38

Baking	39
Baking Table	41
Table for Bakes and Gratins.	45
Frozen Ready Meals Table	46
Roasting	48
Roasting Table.	49
Meat Probe Table	51
Grill Sizes	52
Grilling Table.	53
Drying	54
Drying Table	54
Defrosting	55
Defrosting table	55
Bio Functions	56
Making Yoghurt	56
Raising yeast dough	56
Low Temperature Cooking.	57
Low Temperature Cooking Table	57
Making Preserves	58
Preserving Table	58
Programmed Functions and Recipes	59
Cleaning and care	66
Exterior of the Appliance	66
Oven Interior	66
Accessories	67
Grease Filter	67
Side Rails.	68
Steam Generation System.	70
Oven Light	71
Oven Door.	73
What to do if	74
Technical Data	75
Oven Interior Dimensions	75
Regulations, Standards, Directives.	75
Installation Instructions	76
Safety Instructions for the Installer.	76
Index	82
Service and Spare Parts	83

Operating Instructions



Safety

Electrical Safety

- This appliance must be connected by a **specialty licensed technician** only.
- In the event of a fault or damage to the appliance: take the fuses out or switch off.
- For safety reasons, **do not** clean the appliance with steam jet or high-pressure cleaning equipment.
- **Repairs** to the appliance must be carried out by a **specialty licensed technician** only. Considerable danger may result from improper repairs. If repairs become necessary, please contact our Customer Services or your dealer.

Child Safety

- Never leave children unsupervised when the appliance is in use.

Safety during Operation

This appliance should be used only for normal domestic cooking, roasting and baking of food.

- Be careful if connecting electrical appliances to sockets near to this appliance. Electrical leads should **not** be allowed to come near the hotplates or to become caught under the hot oven door.
- **Warning: Danger of burns!** When in use, the oven interior surfaces become very hot.
- **Caution: During steam cooking, do not under any circumstances open the oven door.** The escaping steam can cause moisture damage to furniture and cabinets. Avoid any direct contact with escaping steam.
- If you use alcohol in your cooking, a slightly flammable alcohol/air mixture may ensue. In this case, be careful when opening the door. Do not handle any sources of heat, sparks or naked flames when doing so.

How to avoid damage to the appliance

- Do not line the oven with aluminium foil and do not place baking trays, pots, etc. on the oven floor, as the heat that builds up will damage the oven enamel.
- Fruit juices dripping from the baking tray will leave stains, which you will not be able to remove. For very moist cakes, use the all-purpose tray.
- Do not put any strain on the oven door when open.
- Never pour water directly into the oven. This could cause electrical faults or damage to the enamel.
- Rough handling, especially around the edges of the front panel, can cause the glass to break.
- Do not store any flammable materials inside the oven. These could ignite when the oven is switched on.
- Do not store any moist foods inside the oven. This could damage the oven enamel.



Disposal

Disposing of the packaging material

All materials used can be fully recycled.

Plastics are marked as follows:

- >PE< for polyethylene, as used for the outer wrapping and the bags inside.
- >PS< for polystyrene foam, e.g., as used for the padding materials. They are completely free of CFCs.

Disposal of old appliances



Warning: Before disposing of old appliances please make them inoperable so that they cannot be the source of danger.

To do this, disconnect the appliance from the mains supply and remove the mains lead.

To protect the environment, it is important that worn out appliances are disposed of in the correct manner.

- The appliance must not be disposed of with household rubbish.
- You can obtain information about collection dates or public refuse disposal sites from your local Council or Environmental Health Office.

Description of the Appliance

General Overview

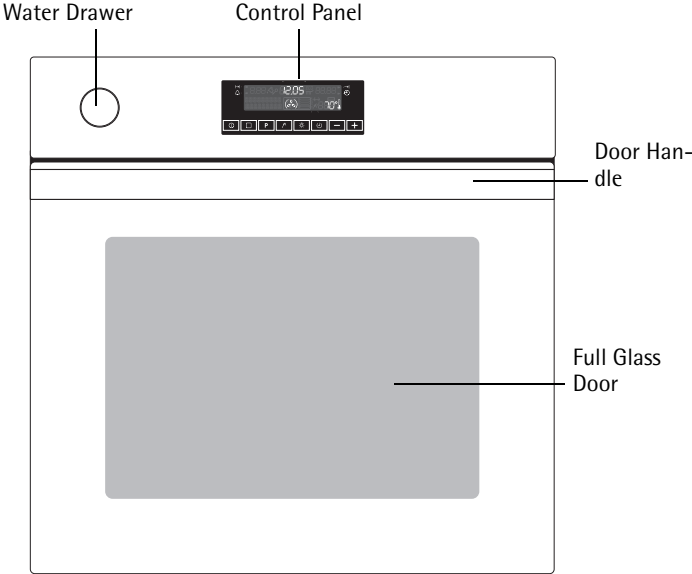

Control Panel

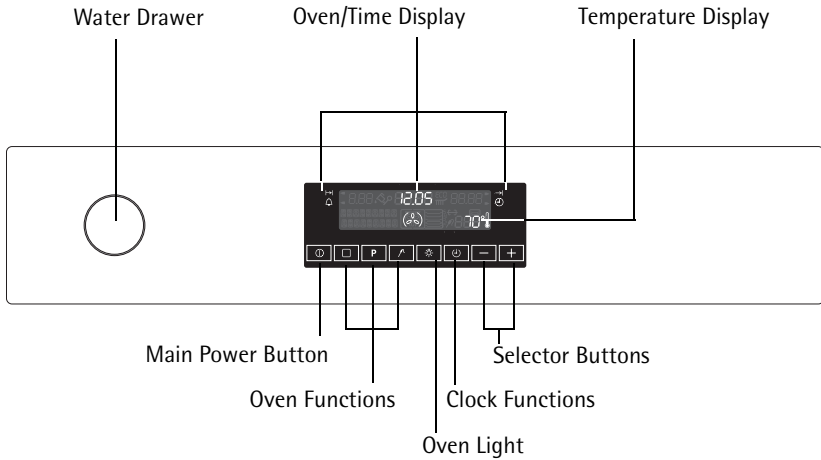

Oven Features

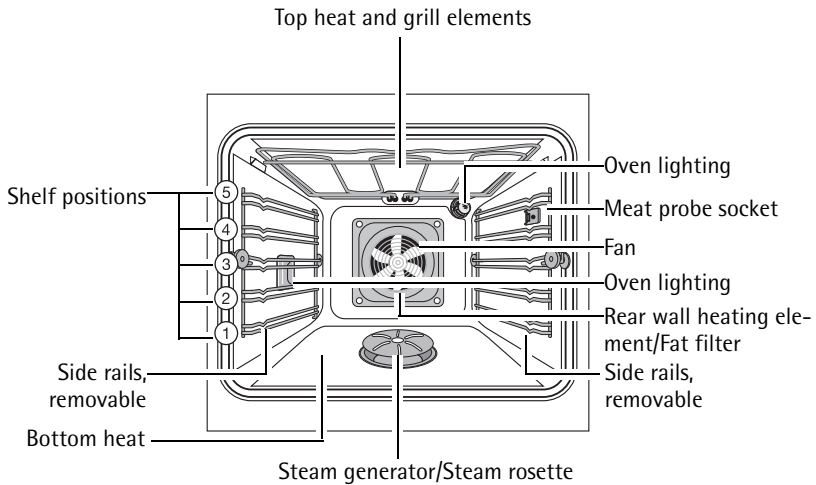

Oven Accessories

Combination shelf

For dishes, cake tins, items for roasting and grilling.

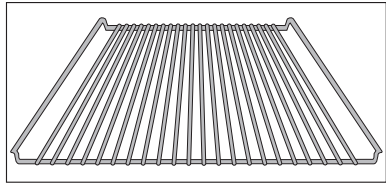

Baking Tray

For cakes and biscuits
(not suitable for steam cooking)

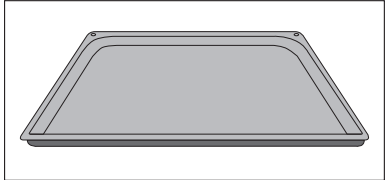

All-purpose tray

For roasting or for collecting meat juices or fat (not suitable for steam cooking)

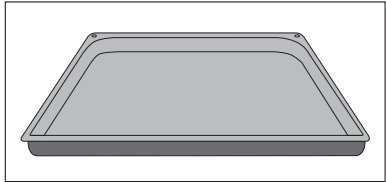

Inner tray

For fatty meat (for positioning in All-Purpose tray, not suitable for steam cooking)

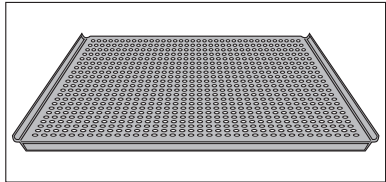

Meat probe

Used on joints of meat to determine exactly how well done they are during cooking (not suitable for steam cooking)

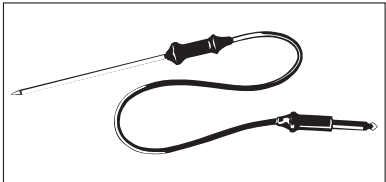



Before using for the first time

Setting the clock

i The oven only operates when the time has been set.

When the appliance is connected to the electrical supply or when there has been a power cut, the arrow for the clock  flashes.



Set the current time with the  or  button.

Wait 5 seconds.

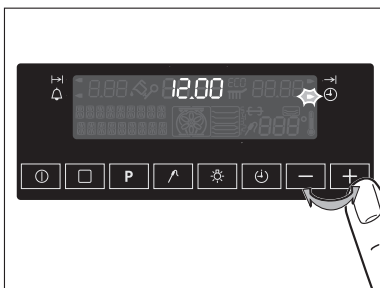

The flashing stops and the clock displays the time of day set.

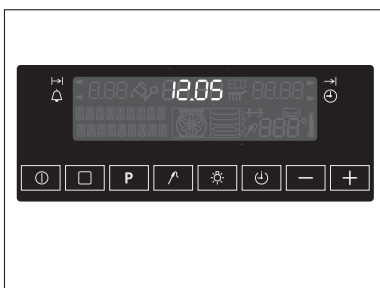

The appliance is now ready to use.



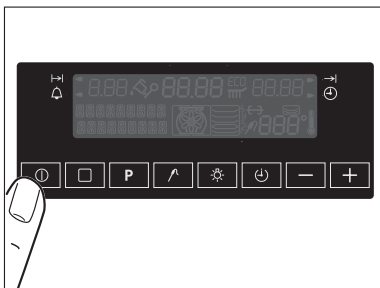

Setting the Language

1. Switch the appliance on by pressing the main power button .



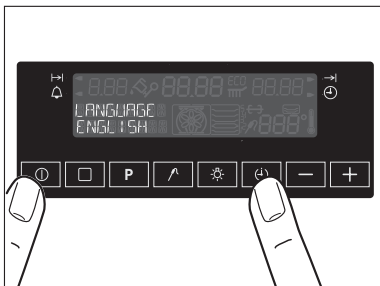

2. Press the main power  and the clock function  buttons at the same time.

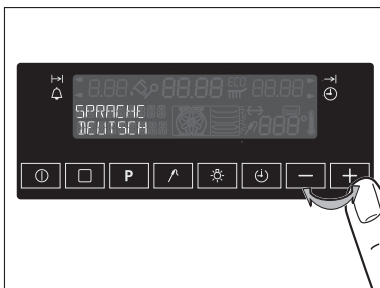

3. Using the selector buttons  and  select one of the languages suggested.



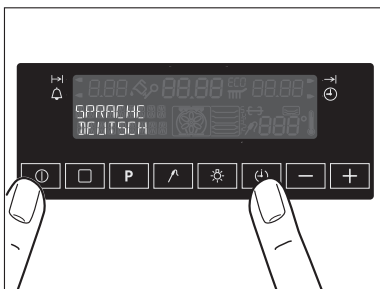

4. Press the main power  and the clock function  buttons at the same time, to store the selected language.



Setting the Display Brightness

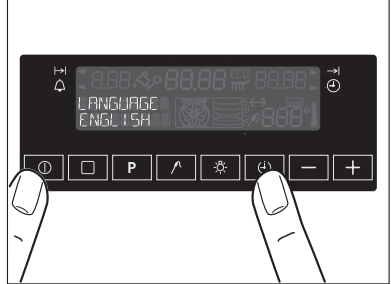

The brightness of the display can be adjusted, to make it easier to read in ovens built-in at higher levels.

1. Switch the appliance on by pressing the main power button .
2. Press the main power  and the clock function  buttons at the same time.



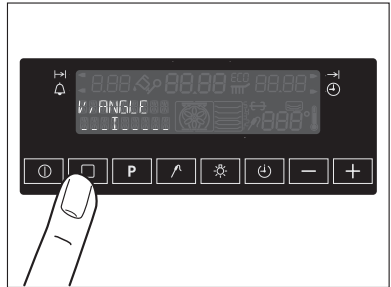

3. Press the Oven Functions  button.

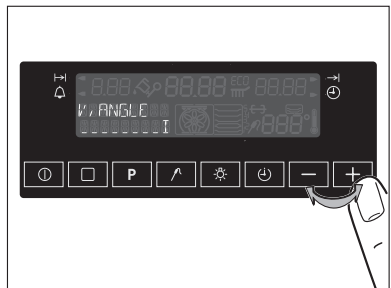

4. Set the brightness with the  or  button.



5. Press the main power  and the clock function  buttons at the same time, to store the brightness setting selected.

Initial Cleaning

You should clean the oven thoroughly before using for the first time.



Attention: do not use sharp or abrasive cleaning materials. These could damage the oven surface.



For ovens with metal fronts, use normal commercially available cleaning agents.



1. Press the main power button . The oven light comes on.
Open the oven door.
2. Remove all accessories and the side rails and clean with warm water and washing-up liquid.
3. Wash the oven in the same way, with warm water and washing-up liquid and leave to dry.
4. Wipe the front of the appliance with a damp cloth.

Operating the Oven

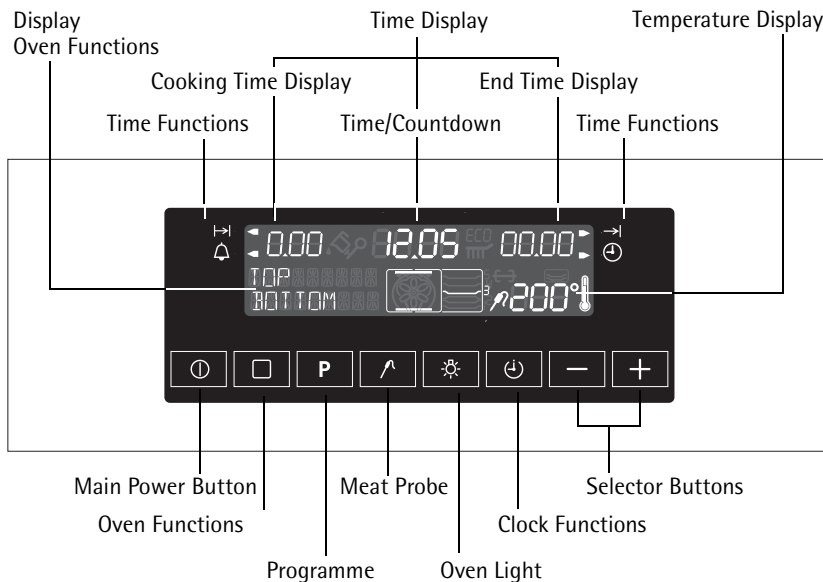
The Electronic Oven Control



General Instructions

- Always switch the appliance on first by pressing the main power switch .
- When the selected function is lit, the oven begins to heat up or the time set begins to count down.
- Switch on the oven light using the  button.
- Switch the appliance off by pressing the main power switch .
- When the selected temperature is reached, an audible signal sounds.

Oven Functions

The oven has the following functions:



The functions **Conventional (Top/Bottom heat)**, **Pizza setting** and **Rotitherm** have an **automatic rapid heating function**. This ensures that the temperature set is reached as quickly as possible.

Vigorous Steam

Fixed temperature setting: 96°C.

For vegetables, potatoes, rice, pasta or other side-dishes.

Steam generator and fan are on.

Interval Steam

Suggested temperature: 180°C.

For **baking** and **roasting** and warming up frozen or chilled meals.

Fan and steam generator operate alternately.

Fan Cooking

Suggested temperature: 150°C.

For **baking on up to three oven shelves** and for **roasting**.

The rear heating element is on and the fan is also switched on.

Pizza Setting

Suggested temperature: 200 °C.

For **baking** cakes on **one oven shelf** and cakes, pastries or biscuits that require more intensive browning and a crispy base or crust. This might include, for example, pizzas, quiches, fruit flans, cheesecakes, etc.

Bottom and rear heating elements are on and in addition the fan is switched on.

Rotitherm

Suggested temperature: 180 °C

For **roasting** larger pieces of meat or poultry on one level. This function is also suited to **cooking foods au gratin** and **browning**.

The grill heating element and top heat operate alternately with the fan.

Dual Grill

Suggested temperature: 230°C

For **grilling** flat foodstuffs in **large quantities**, for example, steaks, escalopes, fish, or for **toasting**.

Top heat and grill heating elements are on.

Single Grill

Suggested temperature: 230°C.

For **grilling** flat foodstuffs **placed in the centre of the grill**, for example, steaks, escalopes, fish, or for **toasting**.

The grill heating element is on.

Top/Bottom Heat (conventional oven)

Suggested temperature: 200°C

For **baking** and **frying/roasting** on one **shelf position**.

The Top and Bottom Heat heating elements are on.

Drying/Defrosting

Suggested temperature: 30°C.

For **drying** herbs, fruit and vegetables and for **defrosting**.

Bottom heating element and fan are on.

Low Temperature Cooking



Fixed temperature setting: 120/80 °C.

For preparing especially tender, succulent **roasts**.

Rear heating element and fan are on.



Switching the Oven On and Off

Switching on the oven function

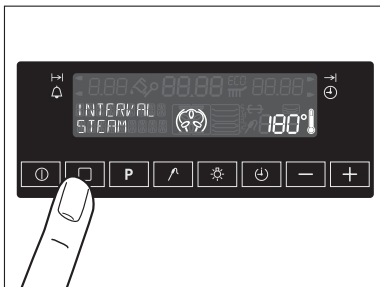
1. Switch the appliance on by pressing the main power switch .
2. Press the Oven Function  button as often as necessary, until the desired oven function is lit.
 - A suggested temperature appears on the temperature display.
 - If the suggested temperature is not changed within approx. 5 seconds, the oven begins to heat up.



Changing oven temperature

Press the  or  button, to raise or lower the temperature. The setting changes in steps of 5°C.



Thermometer symbol

- The slowly rising thermometer symbol indicates how hot the oven is as it heats.
- The three segments of the thermometer symbol show that fast heating is working.

Checking the temperature

Press and at the same time.

The current temperature appears in the temperature display.

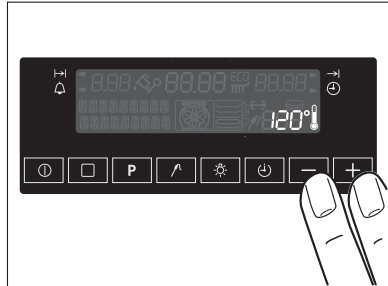

Changing the oven function

Press the OVEN FUNCTION button as often as necessary, until the desired oven function appears.

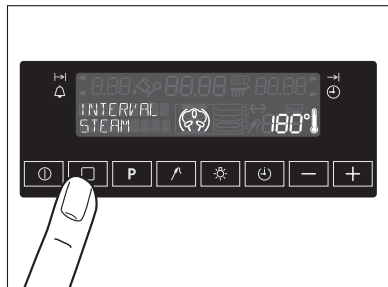

Switching off the oven function

To switch off the oven, press the OVEN FUNCTION button, as often as necessary, until no oven function is displayed any more.

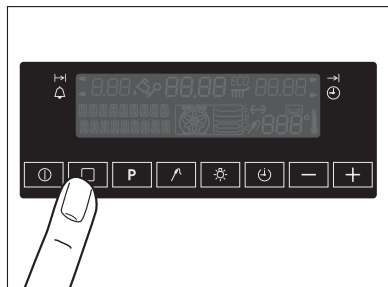

Switching off the oven

Switch the appliance off by pressing the main power switch .

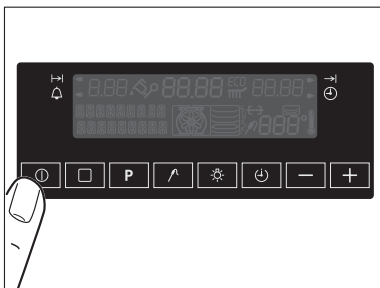

Cooling fan

When the oven is switched on, the fan comes on automatically to keep the surfaces of the appliance cool. When the oven is switched off, the fan continues to operate to cool the appliance down, then switches itself off.

Inserting the general purpose pan, grill, and tray

Inserting the general purpose pan and tray:

The trays have a little bulge on the left and right edges. These are provided as **positioning guides** and must always be located towards the rear when inserting the tray.

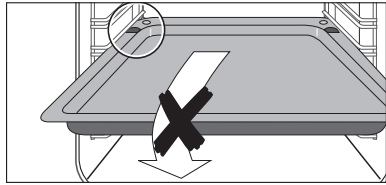

For grills:

Insert the tray at the desired position.

Inserting/Removing the Grease Filter

When roasting, the grease filter protects the rear wall heating element from fat splashes.

Inserting the grease filter



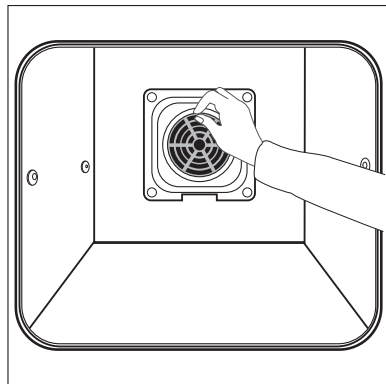



Hold the grease filter by the grip and insert the two mounts downwards into the opening on the rear wall of the oven (fan opening).



Taking out the grease filter

Hold the grease filter by the grip and unhook it.







Steam Cooking Functions

-  **Important:** The steam cooking functions must always be set in conjunction with the clock functions Cook Time  or End Time  (see chapter Clock Functions Cook Time and End Time).
-  **Important: Only** water can be used as liquid.
A buzzing sound is heard when the water has been used up. When more water is added, the buzzing sound is switched off.
-  To prevent limescale forming, only use decalcified water, for example, from a water filter.
-  Because of the automatic steaming dispersal period of approx. 5 minutes at the end of the cooking time and the heating up time of approx. 2 minutes, settings of less than 10 minutes have little effect. During steam dispersal, the oven door may get slightly steamed up. Steam will also escape when the door is opened. The slight condensation on the control panel will quickly evaporate.

Vigorous Steam

1. Water (approx. 700 ml) is not poured directly into the steam generator, but **into the water drawer** in the control panel.

The water supply lasts for approx. 30 minutes.

2. Switch the oven on using the main power switch .
3. Using the Oven Function button  select the Vigorous Steam function.
4. Using the clock function buttons select  Cook Time  or End Time  and using the  or  buttons, set the desired cooking time or switch-off time.

After about 2 minutes, the first steam appears. A single audible signal indicates when the cooking temperature of around 96°C is reached. A triple signal is sounded at the end of cooking time.

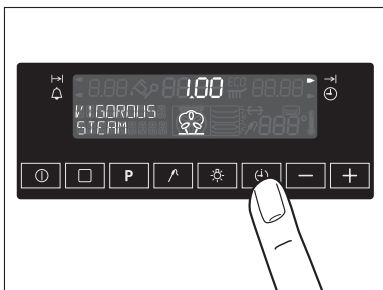
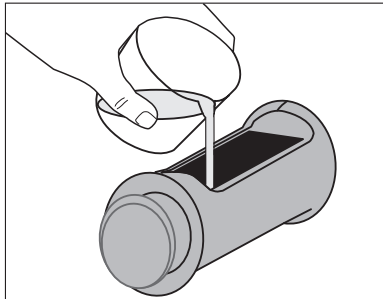









5. Stop the signal and switch off the oven by pressing the main power switch .

After the oven has cooled down, soak up any remaining water from the steam generator using a sponge and, if necessary, wipe out with a little vinegar.

Leave the door open to let the oven dry completely.

Interval Steam

The continual change from fan to steam takes place automatically.

1. The water (about 250 ml) is not poured directly into the steam generator, but **into the water drawer** in the control panel.
The water supply lasts for approx. 60 minutes.
2. Switch the oven on using the main power switch .
3. Using the Oven Function button , select the Interval Steam function and using the  button or the  button set the desired temperature.
4. Using the clock function buttons select  Cook Time  or End Time  and using the  or  buttons, set the desired cooking time or switch-off time.

Then proceed as for Vigorous Steam Cooking.

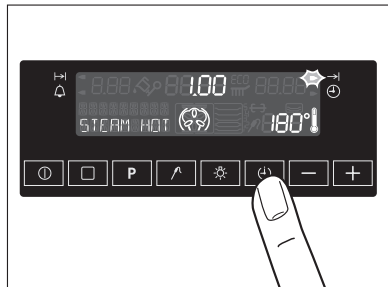

Additional Functions

Baking and Roasting Programmes

i For this function, use the recipes supplied in the chapter "Usage, Tables and Tips".

Selecting baking and roasting programmes

1. Press the Programme **P** button as often as necessary, until the desired baking/roasting programme appears.

- In the function display field the symbols for the oven function and the recommended oven shelf appear.
- The suggested temperature appears on the temperature display.
- The cooking time and the end time appear in the clock display.
- After about 5 seconds, the oven is switched on.
- Before the programme ends, an audible signal sounds.

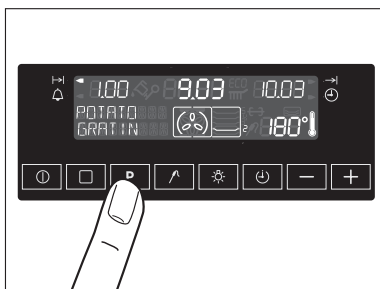

2. Check the cooking at this point.
 - When the cooking time is completed, an audible signal sounds. "0:00" flashes in the clock display.
3. The signal can be stopped by pressing any button.

Delaying the start

The cooking time can be delayed (see Clock Functions End Time).

i The clock function End Time can be set, if the programme has been running for less than two minutes.

Ending the cooking time early

Press the Programme **P** button as often as necessary until no baking/roasting programme is displayed.

Meat Probe

Ensures that the oven switches itself off as soon as the temperature at the centre of a roast reaches a set temperature.

The meat probe is best used together with the Conventional (Top/Bottom heating), Fan Cooking and Rotitherm functions.

There are two temperatures to be set:

- Oven temperature: see Roasting Chart
- Core temperature: see Meat Probe Chart



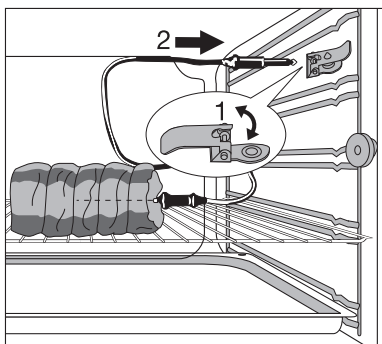

Important: Only the meat probe supplied may be used. If replacing, please use only original replacement parts.

1. Push the tip of the meat probe in as fully as possible, so that the tip is in the centre of the meat.
2. Insert the meat probe plug into the socket on the side wall of the oven, pushing it in fully.



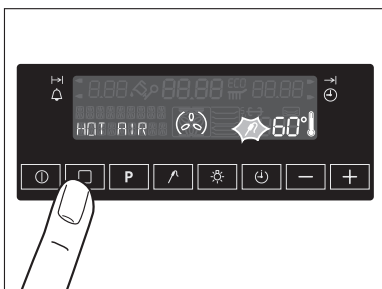

3. Press the Oven Function  button as often as necessary, until the desired oven function appears.



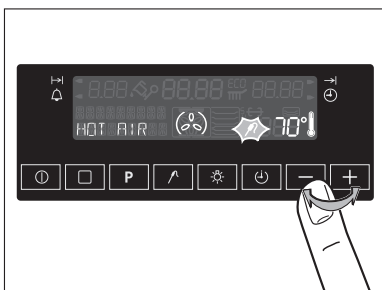

4. Start setting the desired core temperature within 5 seconds, using the  or  buttons. The display changes to the current core temperature.



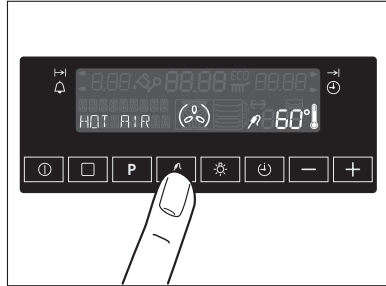

- The core temperature is displayed from 30°C.
- Should the current core temperature already be being displayed, before the desired core temperature is set, press the meat probe  button and carry out the setting process.
- To set the oven temperature, press the meat probe  button twice.



- Start setting the desired oven temperature within 5 seconds, using the  or  buttons.

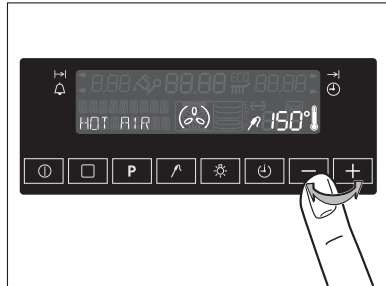

– As soon as the core temperature set is reached, an audible signal sounds and the oven switches itself off automatically.

5. To switch off the signal, press any button.



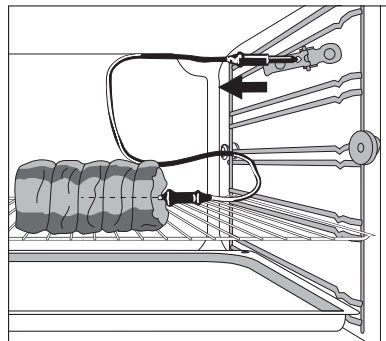

Warning: The meat probe is very hot. There is a risk of being burned when removing the plug and the tip of the meat probe.

6. Remove the meat probe's plug from the socket and take the meat out of the oven with the meat probe still inserted.
7. If applicable, switch off the appliance.



Checking or changing the core temperature

- By pressing the meat probe  button, you can change between the current and the set core temperatures and the set oven temperature.
- If necessary, change the temperature using the  or  buttons.



The automatic oven switch off function **cannot be used in conjunction with** the oven function **Low Temperature Cooking**.

Clock Functions

Countdown

To set a countdown. A signal sounds after the time has elapsed. This function does not affect the operation of the oven.

Cook time

To set how long the oven is to be in use.

End time



To set when the oven is to switch off again.

Time



To set, change or check the time
(See also section "Before Using for the First Time").





General hints

- When a clock function has been selected, the related arrow flashes for around 5 seconds. During this time, the desired setting can be made using the  or  control knob.
- After the desired time has been set, the arrow flashes again for around 5 seconds. The arrow then remains lit. The set time begins to run.

Countdown

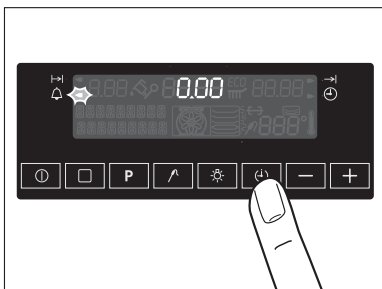
1. Press the clock function  button as often as necessary, until the Countdown arrow  flashes.



2. Set the desired Countdown time using the  or  button (max. 99 minutes).

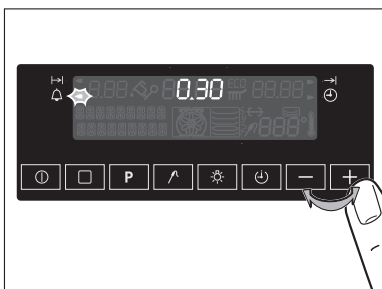

After about 5 seconds the display shows the time remaining.
The Countdown arrow  lights up.





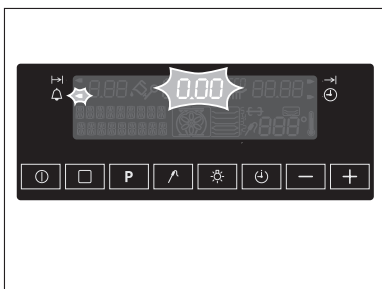

When the time has elapsed, an audible signal sounds for 2 minutes.
"0.00" and the Countdown arrow  flash.



To turn off the audible signal:
Press any button.

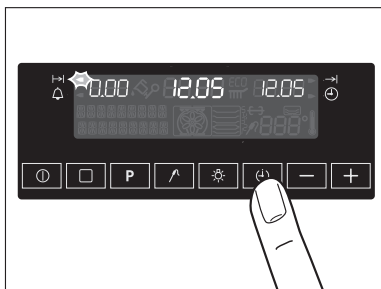

Cooktime

1. To select the oven function and temperature.
2. Press the     button as often as necessary, until the Cooktime arrow  flashes.



3. Set the desired cooking time with the  or  button.

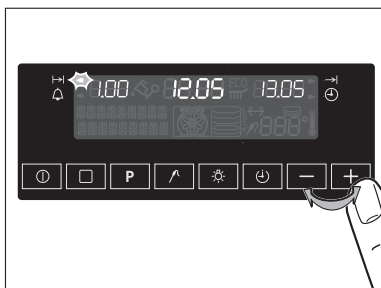

The Cooktime arrow  lights up.

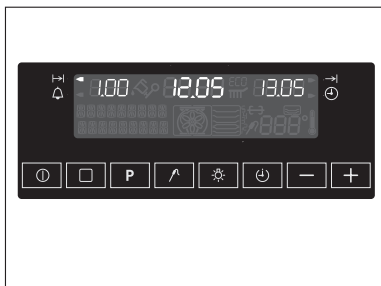

When the time has elapsed, an audible signal sounds for 2 minutes.

The oven switches itself off.



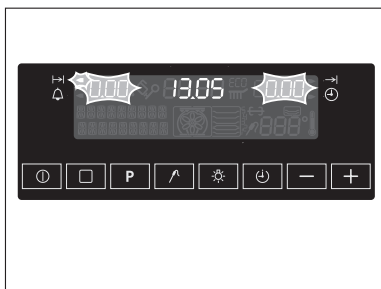

"0.00" and the Cooktime arrow  flash.





To turn off the audible signal:

Press any button.

End Time

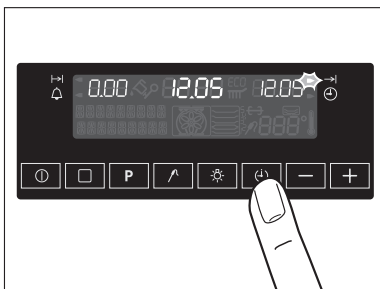
1. To select the desired oven function and temperature.
2. Press the     button as often as necessary, until the End Time arrow  flashes.



3. Set the desired switch-off time with the  or  button.

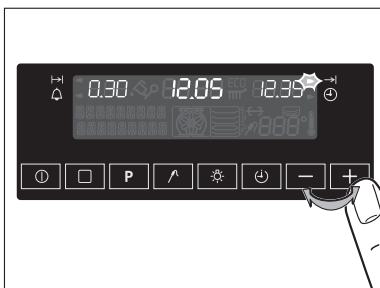

The End Time arrow  lights up.



When the time has elapsed, an audible signal sounds for 2 minutes. The oven switches itself off. "0.00" and the End Time arrow  flash.

To turn off the audible signal:
Press any button.

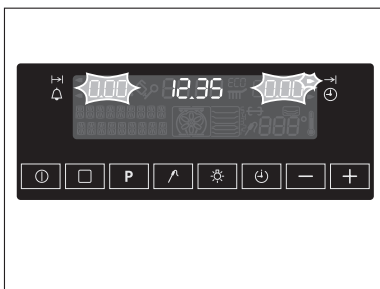



COOK TIME and END TIME combined



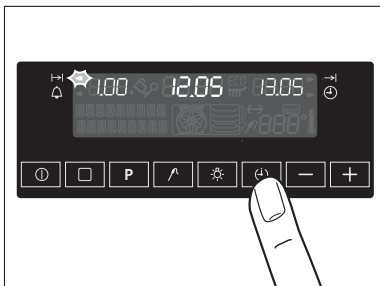

Cook Time and End Time can be used simultaneously if the oven is to automatically switch on and off at a **later time**.

1. To select the desired oven function and temperature.
2. Using the COOK TIME  function, set the time required for cooking the dish concerned, for example, 1 hour.

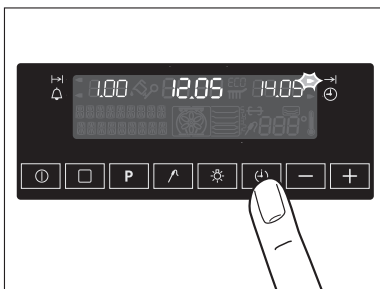

3. Using the END TIME  function, set the time at which the dish should be ready, for example, 14:05.



The COOK TIME  and END TIME  arrows flash.

The oven switches on automatically at the time calculated,

for example, 13:05.

When the set cooking time has elapsed, an audible signal sounds for 2 minutes and the oven switches itself off,

for example, at 14:05.

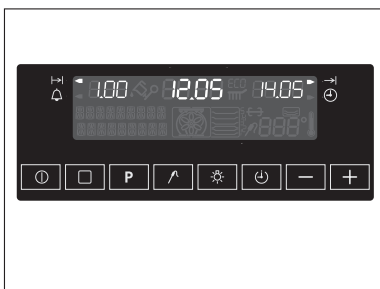

Adjusting the time ⌚

1. Press the clock function ⌚ button as often as necessary, until the Time arrow ⌚ flashes.

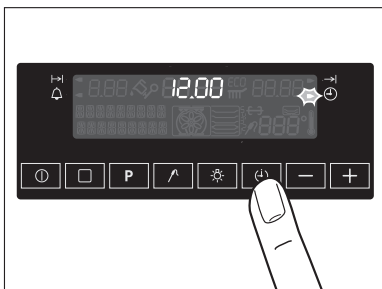

2. Set the current time with the + button or the - button.

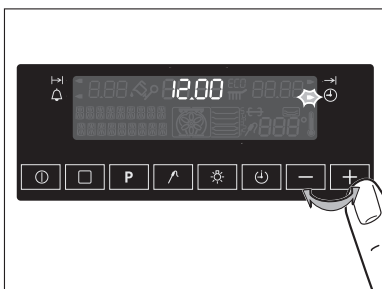

3. After about 5 seconds, the arrow stops flashing and the clock displays the time set. The appliance is now ready to use again.





The time can only be modified, if the child safety device is released, neither of the clock functions COOK TIME ⌚ or END TIME ⌚ nor any oven functions are set.

Other Functions

- i** Between 22:00 and 6:00, the brightness of the display is automatically reduced.

Switching off the clock display

- ♣** You can save energy by switching off the clock display.

1. If required, **switch off** the appliance using the main power switch .
2. Press the meat probe  button and the  button at the same time for as long as necessary, until the display goes out (about 2 seconds).

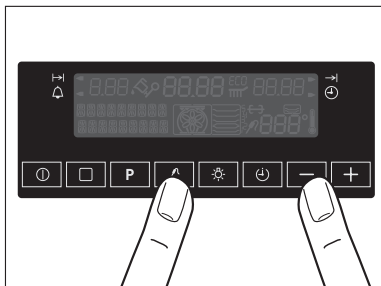



- i** As soon as the oven is switched on again, the display comes on automatically.

When the appliance is switched off again, the clock display goes out again.

To have the clock display on permanently again, you must set the clock again.



Switching on the clock display

1. If required, **switch off** the appliance by pressing the main power switch .
2. Press the meat probe  button and the  button at the same time for as long as necessary, until the display goes out (about 2 seconds).

Child Safety Device

As soon as the child safety device is engaged, the oven cannot be switched on.



Activating the child safety device

1. If required, switch on the appliance by pressing the main power switch . No Oven Function must be selected.
2. Press and hold the Programme  and  buttons at the same time, until CHILD SAFETY appears on the display field.

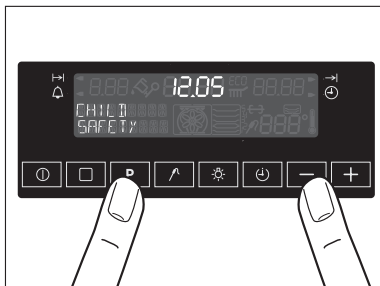
The child safety device is now engaged.



Releasing the child safety device



Press and hold the Programme  and  buttons at the same time, until CHILD SAFETY disappears from the display field.

The child safety device is now released and the oven is again ready for use.

Button Lock



To ensure that oven functions set are not accidentally altered.

Setting the Button Lock

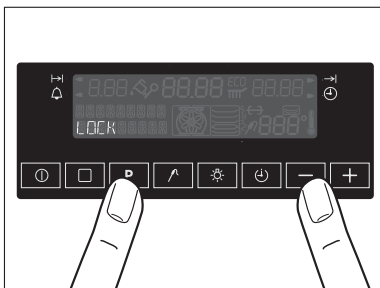
1. If required, switch on the appliance by pressing the main power switch .
2. Select the oven function.
3. Press and hold Programme  and  buttons at the same time for about 2 seconds, until PROGRAMME LOCK appears in the display.
The button lock is now engaged.



Releasing the Button Lock

Press and hold Programme  and  buttons at the same time for about 2 seconds.

The button lock is automatically lifted, if the appliance is switched off.

Oven Safety Cut-out



If not switched off after a certain time, or if the temperature is not modified, the oven switches off automatically. The last temperature set flashes in the temperature display and an audible signal sounds.

The oven switches off when the oven temperature is:

30	- 120°C	after	12.5 hours
120	- 200°C	after	8.5 hours
200	- 230°C	after	5.5 hours

Switching on after a safety cut-out

Switch the oven off completely.
It can then be switched on again.

Usage, Tables and Tips

Steam Cooking

For steam cooking, use either the Vigorous Steam or Interval Steam oven functions.



Warning: During steam cooking, do not under any circumstances open the oven door.



Attention: Always use water only.

Cookware for Steam Cooking

- Ordinary baking tins, heat-resistant tins and roasting dishes are suitable for steam cooking.
- Do not use enamelled baking tins! Chrome steel food containers are also very suitable.

Oven Levels

- The appropriate oven level can be found in the following table. Be careful to count oven levels starting from the bottom.



General Tips

- For cooking times longer than 30 minutes or when cooking larger quantities, top up water, if necessary.
- With Vigorous Steam and Interval Steam **take out the grease filter**; otherwise, cooking time is longer.
- If not used for long periods, thoroughly rinse out the water drawer, connecting hoses and steam generator (see Chapter "Care and Cleaning").

How to use the Steam Cooking Tables

The Tables give the required temperature settings, cooking times and oven levels for a selection of typical dishes.

- Temperatures and cooking times are for guidance only, as these will depend on the composition and size of the food, the quantity and type of ovenware.
- If you cannot find the settings for a particular recipe, look for the one that is most similar.
- Unless otherwise stated, the values given in the tables assume that steam cooking is started with the oven cold.

Vigorous Steam

The Vigorous Steam Cooking method of preparation is suitable for all types of food, fresh or frozen. It can be used for cooking, warming, defrosting, poaching or blanching vegetables, meat, fish, pasta, rice, sweet corn, semolina and eggs.

A complete menu can be prepared at one time, on the serving dishes, irrespective of quantity or cooking time.

For information, see Table.

Vigorous Steam Table

Type of food	Vigorous Steam (700 ml water)	
	Oven level	Time in mins.
Risotto	2	25-30
Rice	2	35-40
Jacket potatoes, medium-sized	2	45-55
Boiled potatoes	2	35-40
Sauerkraut	2	50-60
Ratatouille	2	25-30
Brussels sprouts	2	30-35
Cauliflower, whole	2	40-45
Tomatoes, whole	2	15-20
Beetroot, whole	2	60-70
Kohlrabi / Celery / Fennel, chopped	2	35-40
Courgettes, chopped	2	20-25
Carrots, chopped	2	30-35
Defrosting and cooking vegetables	2	30-35
Blanching beans	2	20-22
Blanching vegetables	2	12-15
Tender veal ham 1000 g	2	50-75
Smoked loin of pork 600-1000 g	2	45-55
Warming up meat loaf in 1 cm slices	2	20-25
Trout, 170-300 g	2	15-25
Eggs, soft	2	8-10

Type of food	Vigorous Steam (700 ml water)	
	Oven level	Time in mins.
Eggs, medium	2	10-12
Eggs, hard	2	15-20

Vigorous Steam and Fan Cooking in succession

Vigorous Steam and Fan Cooking can be combined to cook meat, vegetables and side-dishes in the oven one after the other and then using Vigorous Steam with one another, so that they will be ready to serve at the same time.

- Cook the roast meat with the Fan Cooking function.
- Put prepared vegetables and accompaniments in oven-proof dishes and place in the oven with the roast.
- Start the Vigorous Steam function and cook it all together until ready.



Before you can start the Vigorous Steam function, the oven must have cooled to a temperature of around 85°C (see temperature display field). For faster cooling, open the oven door.

Vigorous Steam and Fan Cooking in succession

Type of food	Fan cooking		Vigorous Steam (700 ml water)	
	Temp. in °C	Meat Time in mins.	Meat and accompaniments time in mins.	Oven level
Roast beef 1 kg, Brussels sprouts, Polenta	180*	50-60	30-35	1 3
Roast pork 1 kg, Potatoes, Vegetables, Gravy	180*	40-50	30-35	1 3
Roast veal 1 kg, Rice, Vegetables	180*	40-50	30-35	1 3
Chicken 1 kg Roast potatoes, Tomatoes au gratin	190*	40-50	30 10	1 4

Core temperature of meat should be 60-63°C before switching to Vigorous Steam.

* Pre-heat the oven.

Interval Steam

Interval Steam cooking is particularly suitable for roasting large joints of meat and defrosting or re-heating portions of food cooked previously.

Interval Steam Cooking Table

Cooking on more than one oven level

Type of food	Interval steam (250 ml water)		
	Temperature in °C	Time in mins.	Oven level
Reheating complete meal 6 plates, dia. 24 cm	120	15-20	1, 3 and 5
Roast pork 1 kg	180*	55-65	2
Roast beef 1 kg	180*	55-65	2
Roast veal 1 kg	180*	45-55	2
Meat loaf, uncooked, 500 g	180	30-40	2
Veal sausage	90	15-20	2
Frankfurter	90	15-20	2
Smoked loin of pork 600-1000 g	180	35-45	2
Chicken, 1 kg	180*	45-55	2
Duck, 1.5-2 kg	180*	55-65	2
Goose, 3 kg	170*	130-170	1
Fish fillets	90	10-15	2
Potatoes au gratin, Leek/potatoes au gratin	180	40-50	2
Pasta bake	180	35-45	2
Lasagne	180	45-50	2
Misc. types of bread 500-1000 g	190-200	50-60	2
Rolls 50-60 g	200-210	20-25	2

Cut up a whole roast before warming.

* Pre-heat the oven.

Baking

For baking, use either the Fan Cooking, Pizza setting or Conventional oven functions.



When baking, remove the grease filter, as otherwise baking time is prolonged and surfaces are browned unevenly.

Baking Tins

- For Conventional baking (Top/Bottom heat), use dark metal and non-stick tins.
- Bright metal, glass and ceramic baking tins are also suitable for Fan Cooking or Pizza setting oven functions.

Oven Levels

- Conventional baking is only possible on one level.
- With Fan Cooking, you can bake dry, flat biscuits and cookies on up to 3 baking trays at the same time.

1 baking tray:
for example, oven level 3

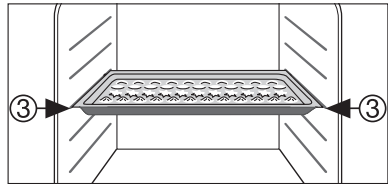

1 baking tin:
for example, oven level 1

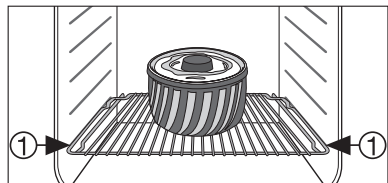

2 baking trays:
oven levels 1 and 4

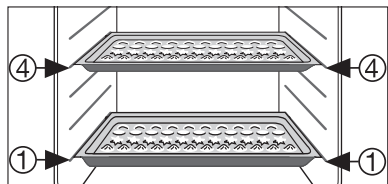

3 baking trays:
oven levels 1, 3 and 5

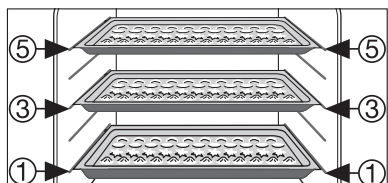

General Instructions

- Be careful to count oven levels starting from the bottom.
- Insert the baking tray with the bevel at the front!
- Always place cakes in tins in the middle of the grill.
- With Conventional (top/bottom heat) or Fan-assisted cooking, you can also bake two cakes at the same time in tins placed next to each other on the grill. This does not significantly increase baking time.



When frozen foods are used the trays inserted may distort during cooking. This is due to the large difference in temperature between the freezing temperature and the temperature in the oven. Once the trays have cooled the distortion will disappear again.

How to use the Baking Tables

The Tables give the required temperature settings, baking times and oven shelf levels for a selection of typical dishes.

- Temperatures and baking times are for guidance only, as these will depend on the consistency of pastry or mixture, the number and the type of baking tin.
- We recommend using the lower temperature the first time and then, if necessary, for example, if a deeper browning is required, or baking time is too long, selecting a higher temperature.
- If you cannot find the settings for a particular recipe, look for the one that is most similar.
- If baking cakes on baking trays or tins on more than one level, baking time may be extended by 10-15 minutes.
- Moist recipes (for example, pizzas, fruit flans, etc.) are baked on one level.
- Cakes and pastries at different heights may brown at an uneven rate at first. If this occurs, **please do not change the temperature setting**. Different rates of browning even out as baking progresses.



With longer baking times, you can switch the oven off about 10 minutes before the end of the baking time, in order to utilise the residual warmth.

Unless otherwise stated, the values given in the tables assume that cooking starts with a cold oven.

Baking Table

Baking on one oven level

Type of baking	Fan Cooking		Conventional Oven		Time for both functions Hours: Mins.
	Oven level	Temperature °C	Oven level	Temperature °C	
Baking in tins					
Ring cake or brioche	1	150-170	1	160-180	0:50-1:10
Madeira cake/ fruit cakes	1	140-160	1	150-170	1:10-1:30
Sponge cake	1	140-160	2	160-180	0:25-0:40
Flan base - short pastry	3	170-180	2	190-210 ¹⁾	0:10-0:25
Flan base - sponge mixture	3	150-170	2	170-190	0:20-0:25
Apple pie	1	150-170	1	170-190	0:50-1:00
Savoury flan (e. g. Quiche Lorraine)	1	160-180	1	190-210	0:30-1:10
Cheesecake	1	140-160	1	170-190	1:00-1:30
Cakes/pastries/breads on baking trays					
Plaited bread/bread crown	3	160-170	3	170-190	0:30-0:40
Christmas stollen	3	160-170 ¹⁾	3	160-180 ¹⁾	0:40-1:00
Bread (rye bread) first of all then	1	180-200 ¹⁾ 140-160	2	230 ¹⁾ 160-180	0:20 0:30-1:00
Cream puffs/Eclairs ²⁾	3	160-170 ¹⁾	3	190-210	0:25-0:40
Swiss roll	3	150-170 ¹⁾	3	180-200 ¹⁾	0:10-0:20
Cake with crumble topping ³⁾	3	150-160	3	170-190	0:20-0:40
Buttered almond cake/ sugar cakes	3	160-170 ¹⁾	3	190-210 ¹⁾	0:15-0:30
Fruit flans (made with yeast dough/ sponge mixture)	3	140-160	3	170-190	0:25-0:50

Type of baking	Fan Cooking		Conventional Oven		Time for both functions Hours: Mins.
	Oven level	Tempera- ture °C	Oven level	Tempera- ture °C	
Fruit flans made with short pastry ²⁾	3	150- 170	3	170-190	0:40-1:20
Yeast cakes with delicate toppings/fillings (e. g. cream cheese, cream, etc)	-	-	3	170-190	0:40-1:20
Pizza (with a lot of top- ping) ²⁾	1	180-200	1	190-210¹⁾	0:30-1:00
Pizza (round baking sheet)	1	230 ¹⁾	1	230 ¹⁾	0:10-0:25
Unleavened bread, pitta bread	-	-	2	230 ¹⁾	0:15-0:25
Tarts (CH)	1	180-200	1	210-230	0:35-0:50
Biscuits					
Short pastry biscuits ³⁾	3	150-160	3	170-190 ¹⁾	0:06-0:20
Viennese whirls ³⁾	3	140-150	3	160-180	0:10-0:40
Biscuits made with sponge mixture ³⁾	3	150-160	3	170-190	0:15-0:20
Pastries made with egg white, meringues	3	80-100	3	100-120	2:00-2:30
Macaroons	3	100-120	3	120-140	0:30-0:60
Danish pastries	3	150-160	3	170-190	0:20-0:40
Puff pastries	3	170-180¹⁾	3	190-210¹⁾	0:20-0:30
Rolls	3	170-190 ¹⁾	3	180-220¹⁾	0:20-0:35
Browning					
"Hawaii" toast	3	200-220	3	230 ¹⁾	0:14-0:16

1) Pre-heat the oven.

2) Use all-purpose tray or drip tray.

3) Baking on 2 levels possible.

The numbers printed in bold indicate the **most suitable oven function or temperature.**

Baking on several shelf positions

Type of cake or pastry	Fan Cooking			Time Hours: Mins.
	Shelf position from bottom		Tempera- ture °C	
	2 Levels	3 Levels		
Cakes and pastries on baking sheets				
Cream puffs/eclairs	1/4	-	160-180 ¹	0:35-0:60
Dry streusel cake	1/4	-	140-160	0:30-0:60
Biscuits				
Shortcrust biscuits	1/4	1/3/5	150-160	0:15-0:35
Small piped biscuits	1/4	1/3/5	140-150	0:20-0:60
Sponge fingers	1/4	-	160-170	0:25-0:40
Meringues	1/4	-	80-100	2:10-2:50
Macaroons	1/4	-	100-120	0:40-1:20
Small pastries made with yeast dough	1/4	-	160-170	0:30-0:60
Small pastries made with puff pastry	1/4	-	170-180 ¹	0:30-0:50
Bread rolls	1/4	-	180-190 ¹	0:30-0:55

1) Pre-Heat oven.

Pizza Setting

The stated baking times are for guidance only.

Type of pastry or cake	Pizza Setting		
	Temperature in °C	Shelf position	Baking time in minutes
Shortcrust pastry			
Large cheesecake (750 g soft cheese, loose-bottomed tin, 26 cm)	150-160	2	60-90 + 10 mins. standing time
Covered fruit pie	150-160	2	45-60
Cheesecake on the tray	150-160	2	45-55
Blackcurrant cake, initial baking for base	160-170	2	15
Blackcurrant cake finish baking	150-160	2	30
Puff pastry			
French apple tart	160-170*	2	40-45
Yeast dough			
Cheesecake	150-160	2	35-45
Pizza	220*	1	15-20
Biscuits			
Anzac nutties	160-170	1	25
Shortcrust and rich pastries			
Spinach quiche	190-200	2	30-35
Bread and bread rolls			
Unleavened bread	200-220*	2	21
Soufflés and dishes au gratin			
Baked cabbage with a crispy topping	180-200	1	30
Macaroni and leek cheese	180-200	1	37

* Pre-heat the oven

Frozen foods	Pizza setting		
Type of pastry or cake	Temperature in °C	Shelf position	Baking time in minutes
Frozen pizza	Follow the manufacturer's instructions as stated on the package	Lay on the grill tray, insert baking tray below (shelf position in accordance with the manufacturer's instructions as stated on the package)	Follow the manufacturer's instructions as stated on the package

Also observe the manufacturer's instructions for all other frozen products.

Table for Bakes and Gratins

	Conventional cooking (top/bottom heat)		Rotitherm		Time
	Oven level, from bottom	Temperature [in °C]	Oven level, from bottom	Temperature [in °C]	Hours: Mins.
Pasta bake	1	180-200	1	160-170	0:45-1:00
Lasagne	1	180-200	1	160-170	0:25-0:40
Vegetables au gratin ^{*)}	1	200-220	1	160-170	0:15-0:30
Baguettes topped with melted cheese*	1	200-220	1	160-170	0:15-0:30
Sweet bakes	1	180-200	-	-	0:40-0:60
Fish bakes	1	180-200	1	160-170	0:30-1:00
Stuffed vegetables	1	180-200	1	160-170	0:30-1:00

* Preheat oven.

Information printed in bold indicates the most suitable oven function for the dish.

Frozen Ready Meals Table

Food to be cooked	Oven level from bottom	Oven function	Temperature	Time
Frozen pizza	3	Conventional oven	as per manufacturer's instructions	as per manufacturer's instructions
Chips* (300-600 g)	3	Rotitherm	200-220°C	15-25 Mins.
Baguettes	3	Conventional oven	as per manufacturer's instructions	as per manufacturer's instructions
Fruit flans	3	Conventional oven	as per manufacturer's instructions	as per manufacturer's instructions

* Note: turn chips 2 or 3 times during cooking.

Tips on Baking

Baking Results	Possible Cause	Remedy
The cake is not browned enough at the bottom	Wrong oven level	Place cake lower
The cake sinks (becomes soggy, lumpy, streaky)	Oven temperature too high	Use a slightly lower setting
	Baking time too short	Set a longer baking time Baking times cannot be reduced by setting higher temperatures
	Too much liquid in the dough	Use less liquid next time. Pay attention to mixing times, especially if using mixing machines
Cake is too dry	Oven temperature too low	Set a slightly higher oven temperature next time
	Baking time too long	Set a shorter baking time
Cake browns unevenly	Oven temperature too high and baking time too short	Set a slightly lower temperature and increase baking time
	Dough is unevenly distributed	Spread the dough evenly on the baking tray
	Grease filter is inserted	Take out the grease filter
Baking time too long	Temperature too low	Set a slightly higher oven temperature next time
	Grease filter is inserted	Take out the grease filter

Roasting

Use the rotitherm or conventional oven functions for roasting.

Ovenware for roasting

- Any heat-resistant dish is suitable for roasting (refer to the manufacturer's instructions!).
- If the dish has plastic handles, check that they are heat-resistant (refer to manufacturer's instructions!).
- Large roasts can be roasted **directly on the universal baking tray or on the shelf with the universal baking tray underneath** (e.g. turkey, goose, 3-4 chickens, 3-4 knuckles of veal).
- We recommend that all lean pieces of meat should be roasted **in a casserole dish with a lid** (e.g. veal, marinated beef, pot roast, frozen meat.) In this way the meat will retain its juices.
- In order to obtain a tasty outside crust we recommend roasting pieces of meat in a **casserole dish without a lid** (e.g. roast pork, lamb and mutton, meat loaf, duck, 1-2 knuckles of veal, 1-2 chickens, small fowl, roast beef, fillets, game).



Tip: The oven will be less dirty if you always use a dish for roasting!

Shelf positions

- Please see the following table for the shelf positions to be used.



Notes on the roasting table

Information is given in the table on suitable oven functions, temperature settings, cooking times and shelf positions for various types of meat. The information is for guidance.

- We recommend roasting meat and fish **with a minimum weight of 1 kg in the oven.**
- In general the conventional oven function is particularly suitable for very lean meat such as fish or game. For all other types of meat (particularly poultry) we recommend the rotitherm function.
- To stop meat juices or fat burning onto dishes or the oven, we recommend adding a little water to the roasting dish.
- Turn the joint as required (after 1/2 - 2/3 of the cooking time).



Tip: Baste large joints and poultry several times during cooking with the meat juices. This will produce better roasting results.



Switch off the oven approx. 10 minutes before the end of the cooking time to make use of the residual heat.

Roasting Table

Type of Meat	Quantity	Conventional		Rotitherm		Time
	Weight	Oven Level from Bottom	Temperature °C	Oven Level from Bottom	Temperature °C	Hrs. mins.
Beef						
Pot roast	1-1.5 kg	2	200-230	-	-	2:00-2:30
Roast beef or fillet						each cm. thick
- inside raw	each cm. thick	2	230 ¹⁾	2	190-200	0:05-0:06
- inside rare	each cm. thick	2	230 ¹⁾	2	180-190	0:06-0:08
- well done	each cm. thick	2	210-230 ¹⁾	2	170-180	0:08-0:10
Pork						
Shoulder, Neck, Ham	1-1.5 kg	2	210-220	2	160-180	1:30-2:00
Cutlet, Loin	1-1.5 kg	2	180-190	2	170-180	1:00-1:30
Meat loaf	750 g-1 kg	2	170-180	2	160-170	0:45-1:00
Knuckles of pork (pre-cooked)	750 g-1 kg	2	210-220	2	150-170	1:30-2:00
Veal						
Roast veal	1 kg	2	210-220	2	160-180	1:30-2:00
Knuckles of veal	1.5-2 kg	2	210-225	2	160-180	2:00-2:30
Lamb						
Leg of lamb, Roast lamb	1-1.5 kg	2	210-220	2	150-170	1:15-2:00
Saddle of lamb	1-1.5 kg	2	210-220	2	160-180	1:00-1:30

Type of Meat	Quantity	Conventional		Rotitherm		Time
	Weight	Oven Level from Bottom	Temperature °C	Oven Level from Bottom	Temperature °C	Hrs. mins.
Game						
Chine of hare, Leg of hare	up to 1 kg	3	220-230 ¹	3	160-170	0:25-0:40
Saddle of venison	1.5-2 kg	2	210-220	2	160-180	1:15-1:45
Haunch of venison	1.5-2 kg	2	200-210	2	160-180	1:30-2:15
Poultry						
Poultry portions 4-6 pieces	each 200-250 g	3	220-230	3	180-200	0:35-0:50
Chicken halves 2-4 pieces	each 400-500 g	3	220-230	3	180-200	0:35-0:50
Chicken, Fatted chicken	1-1.5 kg	2	220-230	2	170-180	0:45-1:15
Duck	1.5-2 kg	2	210-220	2	160-180	1:00-1:30
Goose	3.5-5 kg	2	200-210	2	150-160	2:30-3:00
Turkey	2.5-3.5 kg	2	200-210	2	150-160	1:30-2:00
	4-6 kg	2	180-200	2	140-150	2:30-4:00
Fish (steamed)						
Whole fishes	1-1.5 kg	2 / 3	210-220	2 / 3	160-170	0:45-1:15

1) Pre-heat the oven.

Information printed in bold indicates the **best oven function**.

Meat Probe Table

Food to be cooked	Meat core temperature
Beef	
Pot roast	90 - 95°C
Rib steak or filet steak, rare	45 - 50°C
medium	60 - 65°C
well done	75 - 80°C
Pork	
Shoulder of pork, ham joint, neck	80 - 82°C
Chop (saddle), smoked pork loin	75 - 80°C
Meat loaf	75 - 80°C
Veal	
Roast veal	75 - 80°C
Knuckle of veal	85 - 90°C
Mutton / Lamb	
Leg of mutton	80 - 85°C
Saddle of mutton	80 - 85°C
Roast lamb, leg of lamb	75 - 80°C
Game	
Saddle of hare	70 - 75°C
Leg of hare	70 - 75°C
Whole hare	70 - 75°C
Saddle of venison	70 - 75°C
Haunch of venison	70 - 75°C

Grill Sizes

For grilling, use either the Single Grill or Dual Grill oven functions with the 230°C temperature setting.



Important: Always grill with the oven door closed.



The empty oven should **always be pre-heated for 3 minutes!**

Ovenware for grilling

- For grilling, use the oven shelf with the all-purpose tray placed underneath.

Oven Levels

- For grilling flat foods, **the 4th oven level** is normally used.

How to use the Grilling Table

These grilling times are for guidance only, and will depend on the type and quality of the meat, or fish.

- Grilling is particularly suitable for flat pieces of meat or fish.
- Turn the grilled food at about half way through the grilling time.

Grilling Table

Grilled item	Function	Temperature in °C	Universal tray	Grid	Grill time in minutes	
			Shelf position		1st Side	2nd Side
4-8 pork chops	Dual grill	230	1	4	15	12
2-4 pork chops	Single grill	230	1	4	14	12
Marinated pork steaks	Dual grill	230	1	4	12	14
2-4 fillet steaks, rare	Single grill	230	1	4	5-7	6-8
4 fillet steaks, medium	Dual grill	230	1	4	6-8	7-9
2 chicken portions	Single grill	230	1	4	15-20	18-22
4 chicken portions	Dual grill	230	1	3	15-20	18-22
1-4 legs of chicken	Dual grill	230	1	4	20	14
4-6 legs of chicken	Dual grill	230	1	4	20	18
Grilled sausages, up to 6	Single grill	230	1	4	5-10	7
Grilled sausages, 6 and above	Dual grill	230	1	4	5-10	7
Coiled sausages up to 4	Single grill	230	1	4	10	11
Coiled sausages up to 6	Dual grill	230	1	4	10	12
Whole fishes	Dual grill	230	1	3	12	---
Toast (without topping)	Dual grill	230	1	4	1-2	1-2

Drying

For drying, use the Defrost/Dry oven function.

Ovenware

- Use the oven shelf or baking tray, spread with grease-proof or baking paper.

Oven Levels

- You can dry food on 2 oven levels at the same time.
- Place the shelf or the baking tray in the **1st and 4th levels from the bottom**.

Tips on using the Drying Table

- Prepare the food to be dried and distribute it evenly over the shelf or baking tray.
- Halfway through the drying time, turn the food.
- When the food is still bendable but no more juice is coming out, remove it from the oven.

Drying Table

Food	Temperature °C	Time Hours
Vegetables		
Beans	75	6 - 8
Chilli peppers (chopped)	75	6 - 8
Vegetables for soup	75	5 - 6
Mushrooms	50	6 - 8
Herbs	40 - 50	2 - 3
Fruit		
Plums	75	8 - 10
Apricots	75	8 - 10
Apple slices	75	6 - 8
Pears	75	6 - 9

Defrosting

For defrosting, use the Defrost/Dry oven function with the 30°C temperature setting.

Cookware for defrosting

- Unpack the food and set it on a plate on the oven shelf.
- Do not cover with a plate or bowl, as these can substantially lengthen the defrosting time.

Oven Levels

- For defrosting, place the shelf on the **1st oven level**.

Tips on using the Defrosting Table

The following table provides a guide for defrosting times.

Defrosting table

Item	Defrosting time (mins.)	Further defrosting time (mins.)	Comments
Chicken, 1000 g	100-140	20-30	Set the chicken on an upturned saucer placed on a large plate. Half way through, turn over or cover with foil.
Meat, 1000 g	100-140	20-30	Half way through, turn over or cover with foil.
Meat, 500 g	90-120	20-30	Half way through, turn over or cover with foil.
Trout, 150 g	25-35	10-15	Do not cover.
Strawberries, 300 g	20-30	10-20	Do not cover.

Bio Functions

The low temperatures that can be set with this oven can be used to make yoghurt or to raise yeast dough.



Attention: the suggested temperatures have to be changed with all Bio functions!

Making Yoghurt

For making yoghurt, use the Conventional (Top/Bottom heat) oven function.

Ovenware

- To hold the yoghurt, use cups or glasses of around 150 ml. capacity, covered with foil or a lid.

Oven level

- Always insert the shelf on the **3rd level from the bottom**.

1. Bring some milk to the boil (for example, 1 litre for 6-8 servings).
2. Let the milk cool to 40 °C.
3. Stir a carton of natural yoghurt (about 150 g) into the milk, then pour into containers and cover.
4. Place the containers on the shelf.
5. Select the Conventional oven function using the OVEN FUNCTION button and **change the suggested temperature to 40 °C**.
6. After approx. 5-8 hours (or when it has set), take out the yoghurt.

Raising yeast dough

For raising dough, use the Conventional oven function.

Ovenware

- To contain the dough, use a bowl that is heat-resistant to 40 °C.

Oven level

Insert the shelf on the **2nd level from the bottom**.

1. Put the dough in the bowl, cover with clear film and place on the shelf.
2. Select the Conventional oven function using the OVEN FUNCTION button and **change the suggested temperature to 40 °C**.
3. Leave the dough to rise until it has doubled in volume.

Low Temperature Cooking

With the Low Temperature cooking function, meat becomes beautifully tender and remains particularly succulent.



When roasting with low temperatures, up to 20 percent less energy is needed than with normal roasting.



Attention: Insert the grease filter when roasting!

Ovenware

- At low temperatures, always roast meats **uncovered**.

Oven level

- The appropriate oven level can be found in the following table.

Tips for cooking at low temperatures

- The first 10 minutes of the programme are used to heat the empty oven to 120°C. The three segments of the thermometer symbol flash in succession. When the pre-heating time is completed, an audible signal sounds.
- The oven switches automatically to a temperature of 80°C. This remains constant for the whole of the cooking time.
- Meanwhile sear the meat in the frying pan, **place it in a roasting tray or directly on the oven shelf with the all-purpose tray or all-purpose pan underneath it** and then roast in the pre-heated oven.



We recommend low temperature cooking for: lean, tender pieces of meat and fish.

Low temperature cooking is not suitable for: for example, pot roasts or roast pork.

For cooking times, see Table.

Low Temperature Cooking Table

Low Temperature Cooking					
		Pre-heating	Cooking		
Type of food	Weight kg	Temperature °C	Temperature °C	Time mins.	Oven level
Roast beef	1-1,5	120	80	90-110	2
Fillet of beef	1-1,5	120	80	90-110	2
Roast veal	1-1,5	120	80	100-120	2

Making Preserves

For making preserves, use the Interval Steam oven function.

Preserving Jars

- For preserving, use only commercially available preserve jars of the same size.



Jars with twist-off or bayonet type lids and metal tins are not suitable.

Oven Levels

- For preserving, use the **lowest oven level**.

Tips on Preserving

- Use the all-purpose tray for preserving. There is enough room on this for up to six 1-litre preserving jars.
- The preserving jars should all be filled to the same level and clamped shut.
- Place the preserving jars on the all-purpose tray in such a way that they are not touching each other.

Preserving Table

Preserve	Temperature °C	Cooking time until simmering (mins.)	Continue cooking at 100 °C (mins.)	Leave to stand with the oven switched off (mins.)
Soft fruit				
Strawberries, Blueberries, Raspberries, Ripe gooseberries	140-150	35-45	---	---
Unripe gooseberries	140-150	35-45	15	---
Stone fruit				
Pears, Quince, Plums, Damsons, Fruit with hard flesh	140-150	35-45	15	---
Vegetables				
Carrots	140-150	50	15	60
Mushrooms	140-150	45	30	60
Mixed pickles	150-160	50	15	---
Kohlrabi, Peas, Asparagus, Beans	150-160	50	80-120	45-60

Programmed Functions and Recipes

The appliance has 12 programmed functions and recipes, which can be selected one after the other using the Programme  button.

1. Cleaning programme
2. Vegetables
3. Potatoes au gratin
4. White bread
5. Rolls
6. Baked fish fillet
7. Steamed trout
8. Pizza
9. Quiche Lorraine
10. Chicken
11. Saddle of veal
12. Heating food

1. Cleaning Programme

The cleaning programme function is described fully in the “Care and Cleaning” chapter

Recipes

2. Vegetables

Ingredients:

- 400 g cauliflower,
- 200 g carrots,
- 200 g kohlrabi,
- 200 g courgettes.

Method:

Rinse cauliflower and divide into florets.

Peel carrots and kohlrabi and cut into pieces.

Wash courgettes and cut into slices 1 cm thick.

Arrange all ingredients in a stainless steel bowl with compartment with holes in it.

Setting

Vegetables

Ovenlevels

1 and 3

Water via water drawer

700 ml

3. Potatoes au gratin

Ingredients:

- 1000 g potatoes,
- salt and pepper, 1 teaspoon of each
- 1 clove of garlic, peeled
- 300 g Greyerz or Emmental cheese, grated,
- 3 eggs,
- 250 ml milk,
- 4 tablespoons cream,
- 1 tablespoon thyme,
- 3 tablespoons butter.

Method:

Peel potatoes, slice thinly, dry and then salt and pepper them.

Place half of the slices of potato in a greased, oven-proof dish. Sprinkle some grated cheese over them. Layer the rest of the potato slices over this and sprinkle the rest of the cheese on the top.

Crush the clove of garlic and beat together with the eggs, milk, cream and the thyme. Salt the mixture and pour over the potatoes.

Place knobs of butter on the gratin.

Setting	Oven level	Water via water drawer
Potatoes au gratin	2	200 ml

4. White bread

Ingredients:

- 1000 g flour, type 405,
- 1 cube of fresh yeast or 2 packets of dried yeast,
- 600 ml milk,
- 15 g salt.

Method:

Place the flour and the salt in a large bowl. Dissolve the yeast in the milk and add to the flour. Knead all ingredients into a workable dough. Leave the dough to rise until it doubles in volume.

Form two loaves from the dough and lay them on the baking tray covered with baking paper. Leave the loaves to rise again by half their volume.

Before baking, dust them with flour and with a sharp knife cut 3 diagonal lines, at least 1 cm deep.

Setting	Oven level	Water via water drawer
Bread	2	200 ml

5. Rolls (40 g)

Ingredients:

- 500 g flour, type 405,
- 20 g of fresh yeast or 1 packet of dried yeast,
- 300 ml water,
- 7 g salt.

Method:

Place the flour and the salt in a large bowl. Dissolve the yeast in the milk and add to the flour. Knead all ingredients into a workable dough. Leave the dough to rise until it doubles in volume.

Cut dough into pieces to form rolls and lay them on the greased baking tray. Leave rolls to rise again for about 15 minutes.

Before baking, cut a cross into the rolls. As an option, sprinkle with poppy, caraway or sesame seeds.

Setting	Ovenlevels	Water via water drawer
Rolls	2 and 4	200 ml

6. Baked fish fillet

Ingredients:

- 700 g pike-perch fillet (or salmon fillet or sea trout fillet),
- 100 g emmental cheese, grated,
- 200 ml cream,
- 40 g breadcrumbs,
- 40 g butter to grease the dish,
- salt, pepper, lemon juice,
- parsley, chopped.

Method:

Sprinkle the fish fillet with lemon juice and leave it to marinate for a while. Then dab off surplus juice using kitchen paper.

Salt and pepper the fish filets on both sides. Lay them in a oven-proof dish.

Mix the cream, grated cheese, breadcrumbs and the chopped parsley and distribute over the fish.

Setting

Fish fillets

Oven level

3

Water via water drawer

200 ml

7. Steamed Trout

Ingredients:

- 4 trout of 200 - 300 g each,
- lemon juice, pepper, salt.

Method:

Wash the trout well inside and out, sprinkle with lemon juice, season a little and place in a stainless steel dish with a colander insert.

Setting

Trout

Ovenlevels

1 and 3

Water via water drawer

700 ml

8. Pizza

1 original baking tray or 2 round baking sheets (dia. 26 cm)

Ingredients for the dough:

- 300 g flour, type 405,
- 180 ml water,
- 15 g yeast,
- 2 tablespoons olive oil,
- 1 teaspoon salt.

Method for the dough:

Dissolve the yeast in the water and with the other ingredients knead to an elastic dough.

Cover the dough and leave it to rise for 30 minutes.

Ingredients for the topping:

- 500 g tomatoes, cut into 4 mm thick slices,
- 200 g salami, cut into thin slices,
- 170 g mushrooms, sliced,
- 300 g mozzarella, cut into dice 1 cm across.

Preparation:

Roll out the dough, lay it on the tray and cover it with the topping ingredients in the order given.

Leave it to rise again for 20 minutes.

Setting

Pizza

Oven level

2

9. Quiche Lorraine

Ingredients for the pastry:

- 250 g flour, type 405,
- 125 g butter,
- 60 ml water,
- 1 teaspoon salt,
- some pepper and nutmeg.

Method:

Mix together flour, butter and salt, add the water and knead together briefly.

Leave the pastry to cool in the fridge for 1 hour.

Ingredients for the topping:

- 100 ml milk,
- 150 ml sour cream,
- 2 eggs,
- 150 g Greyerz or Emmental cheese, grated,
- 150 g lean ham, diced,
- 150 g onions, diced,
- salt, pepper, nutmeg.

Method:

Steam the ham and onions lightly.

Whisk the milk, cream, eggs and seasoning together well, then mix in the cheese.

Preparation:

Roll out the pastry and place in a plain flan tin with a removable bottom (dia. 28 cm) Distribute the ham and onions over it evenly and pour the liquid mixture over them.

Setting

Quiche Lorraine

Oven level

1

10. Chicken

Ingredients:

- 1 chicken (1000 - 1200 g),
- 2 tablespoons oil,
- salt, pepper, paprika, curry powder.

Method:

Wash the chicken and dry it with kitchen paper.

Mix the spices with the oil and use the mixture to oil the chicken evenly inside and out.

Then place the chicken breast down in an oven-proof dish.

After about 25 minutes, turn the chicken.

After the first audible signal (about 50 mins.) check how it is cooking. If required, leave it to cook for the rest of the roasting time until the second audible signal (about 60 mins.).

Setting	Oven level	Water via water drawer
Chicken	2	200 ml

11. Saddle of veal

Ingredients:

- 1000 g saddle of veal,
- 2 tablespoons oil,
- salt, pepper, paprika.

Method:

Wash the saddle of veal and dry it with kitchen paper.

Mix the seasoning with the oil and use the mixture to oil the meat evenly.

Lay the saddle of veal in an oven-proof dish and place it in the oven.

Setting	Oven level	Water via water drawer
Saddle of veal	2	200 ml

12. Warming food

Method:

Place the food on a plate.

Put it in the oven without a cover.

Setting	Ovenlevels	Water via water drawer
Warming food	1, 3, 5	200 ml

Cleaning and care



Warning: For safety reasons cleaning the appliance with a steam jet cleaner or high-pressure water cleaner is **not permissible!**

Exterior of the Appliance

- Wipe the front of the appliance with a soft cloth dipped in warm soapy water.
- Do not use scourers, caustic cleaners or abrasive items.
- Use commercially available cleaners for metal fronts.

Oven Interior

Cleaning Programme

1. Pour water (approx. 150 ml) and 1 tablespoon of vinegar directly into the steam generator.
2. Start the automatic cleaning programme.
A triple signal is sounded at the end of the cleaning programme.
3. Stop the signal and switch off the oven by pressing the main power switch

Wipe out the oven with a soft cloth.

Remove any residual water from the steam generator.

To completely dry the oven, leave the oven door open for around 1 hour.

Manual Cleaning



Warning: When cleaning, no oven functions must be selected and the oven must have cooled down.



Clean the appliance after each use. In this way, dirt is easier to clean off and is not allowed to burn on.

1. Open the oven door and press the oven light button
2. After every use, wipe the oven with a solution of washing-up liquid and allow to dry. Do not use abrasive objects. If necessary, soak any dirt first or switch on the Vigorous Steam function for a short time.



Clean stubborn dirt with a special oven cleaner.



Important: if using an oven spray, please follow the manufacturer's instructions exactly.

Accessories

Wash all slide-in units (shelf unit, baking tray, shelf support rails etc.) after each use and dry well. Soak briefly to make them easier to clean.

Grease Filter

1. Clean the grease filter in hot water and washing up liquid or in the dishwasher.
2. If dirt has become burnt on, simmer in some water and 2-3 tablespoons of dishwasher detergent.

Side Rails

To clean the sides of the oven, the left and right side rails can be removed from the oven.

Taking out the side rails

1. Loosen the screw.

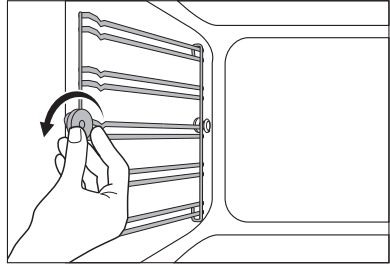

2. Pull the rails sideways (1).

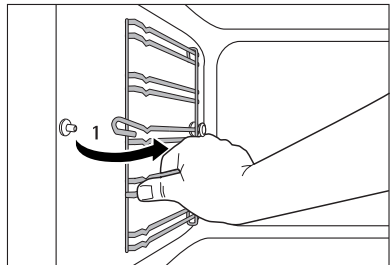

3. Lift the rails off the rear hook (2).

To remove/replace the side rails on the right, open the cover on the meat probe socket.

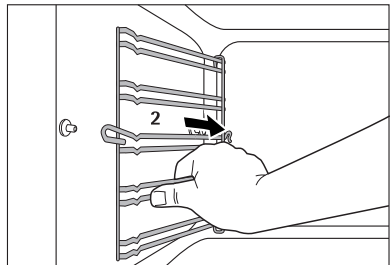

Replacing the side rails

1. Set the rails in the rear hook and press against the screw hole (1).

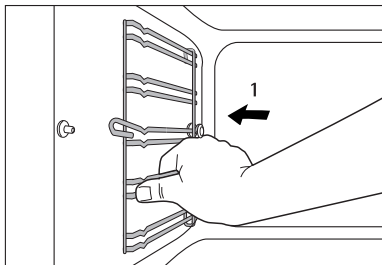

2. Insert the screw and tighten (2).

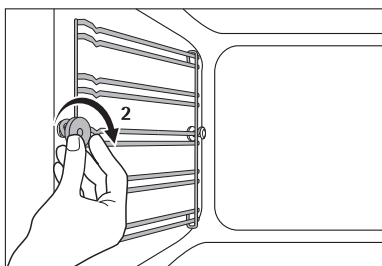

Steam Generation System



Important: Wipe the steam generator dry **after each use**. Soak up water with a sponge.

Remove any lime residue with water and vinegar.

To prevent the build-up of limescale, use only distilled or decalcified water, for example, from a water filter.



Important: Chemical de-scaling agents can damage the oven's surface enamel. Always follow the manufacturer's instructions exactly.

Water Drawer and Steam Generator

1. Water and vinegar (about 200 ml) is not poured directly into the steam generator, but **into the water drawer** in the control panel.

Leave it for about 10 minutes in the steam generator to take effect.

2. Remove the water and vinegar with a non-abrasive sponge.

3. Rinse out the steam generator system **through the water drawer** using clean, decalcified water (100-200 ml).

4. Soak up remaining water from the steam generator with the sponge and wipe dry.

5. Leave the oven door open to let the oven dry out completely.

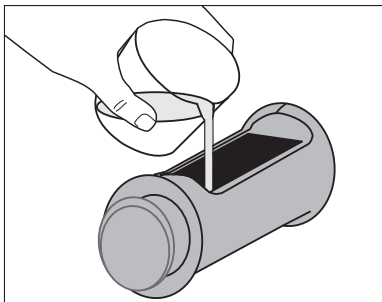

Oven Light



Danger of electric shock! Before replacing the oven light bulb:

- Switch off the oven.
- Take the fuses out of the fuse box or switch off.



To protect the oven light bulb and the glass cover, lay a cloth on the bottom of the oven.

Replacing the rear oven light bulb/ Cleaning the glass cap

1. Take off the glass cap by turning it to the left.
2. Remove seals and metal ring and clean the glass cap.
3. If necessary:
**replace bulb with a 25 Watt,
230 V, 300°C heat-resistant oven
light bulb.**
4. Fit seals and metal ring to the glass cap.
5. Re-fit the glass cap.

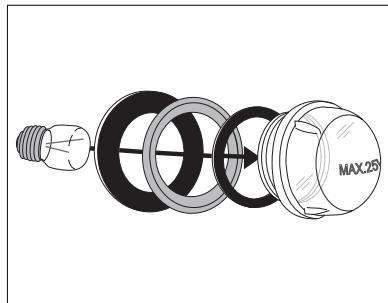
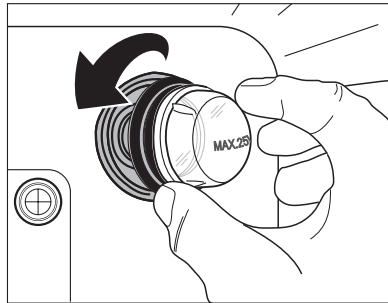

Replacing the side oven light bulb/Cleaning the glass cap

1. Take out the side rails on the left.
2. Unscrew the metal frame using a cross-tip screwdriver.
3. Take off the metal frame and seal and clean them.
4. If necessary:
replace bulb with a 25 Watt, 230 V, 300°C heat-resistant oven light bulb.

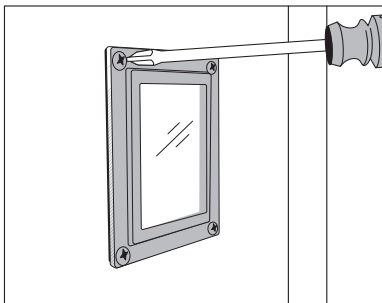

5. Re-fit metal frame and seal and tighten screws.
6. Replace the side rails.

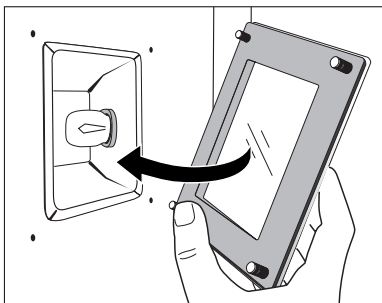

Oven Door

The oven door of your appliance may be removed for cleaning.

Removing the oven door

1. Open the oven door completely.
2. **Completely** fold back the **brass-coloured clamping lever** on **both** door hinges.
3. Grip the oven door with both hands on the sides and close it to about $\frac{3}{4}$ **going past the point of resistance**.
4. Pull the door away from the oven (**Caution: heavy!**).
5. Place the door, with the outer surface downwards, on a soft, flat surface, for example a blanket, to avoid scratches.

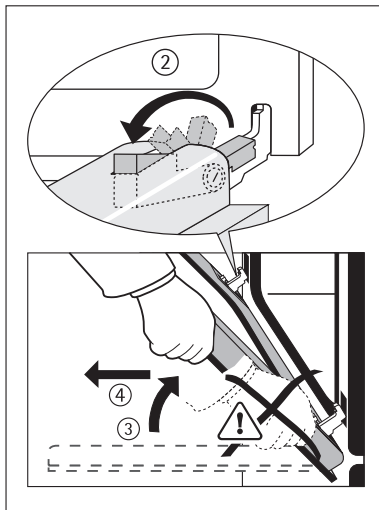

Hanging the oven door

1. With both hands take hold of the sides of the door from the side on which the handle is positioned.
2. Hold the door at an angle of approx. 60° .
3. Slide the door hinges **simultaneously** as far as possible into the two slots on the right and left at the bottom of the oven.
4. Lift the door up until resistance is met and then open fully.
5. Lift the brass-coloured clamping levers on both door hinges back to their original position.
6. Close the oven door.

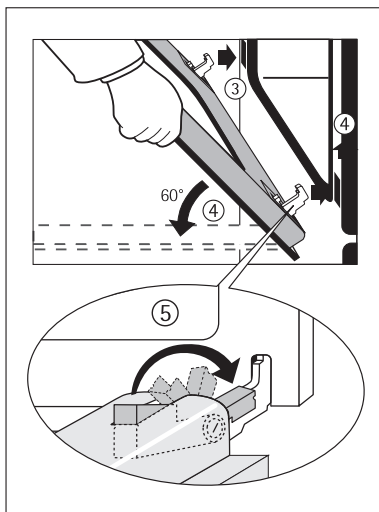

What to do if ...

Fault	Possible cause	Remedy
The oven will not heat.	The oven has not been switched on.	Switch the oven on.
	The correct time has not been set.	Set the correct time.
	The required settings have not been made.	Check the settings.
	The oven's safety fuse has been tripped.	Check the safety fuse.
	The fuse in the domestic wiring system (fuse box) has been tripped.	Check the fuse. If the fuses are tripped repeatedly, please call a qualified electrician.
"F 9" appears on the display.	-	Press the mains button.
The oven is not heating up, and the function display is operating. A small arrow will light up.		Set the oven function to ZERO. Do not switch off the oven. Press and hold down the three centre buttons simultaneously until a signal can be heard.
The oven light will not come on.	The bulb has blown.	Replace the bulb (see Care and Cleaning).

If you are unable to remedy the fault with the above assistance, please contact your specialist dealer or local Service Force Centre.



Caution: Repairs to the appliance should only be carried out by approved service engineers. Repairs carried out by inexperienced persons may cause serious injury to the user.

If the appliance has been used incorrectly, the customer service engineer's visit or that of the specialist dealer will not be free of charge, even during the warranty period.



Advice on cookers with metal fronts:

Because of the cold surface at the front of the cooker, opening the oven door during (or just after) baking or roasting may cause the glass to steam up.

Technical Data

Oven Interior Dimensions

Height x Width x Depth	31 cm x 41 cm x 41 cm
Capacity (usable capacity)	52 l

Regulations, Standards, Directives

This appliance meets the following standards:

- EN 60 335-1 and EN 60 335-2-6
relating to the safety of electrical appliances for household use and similar purposes and
- EN 60350, or DIN 44546 / 44547 / 44548
relating to the operating features of electric cookers, hobs, ovens, and grills for household use.
- EN 55014-2
- EN 55014
- EN 61000-3-2
- EN 61000-3-3
relating to basic requirements for electro-magnetic compatibility protection (EMC)

 This appliance complies with the following EU Directives:

- 73/23/EWG dated 19.02.1973 (Low Voltage Directive)
- 89/336/EWG dated 03.05.1989 (EMC Directive including Amending Directive 92/31/EWG).

Installation Instructions



Important: The new appliance may only be installed and connected by an **approved specialist**.

Please observe this instruction, otherwise the warranty will not cover any damage that may occur.



Safety Instructions for the Installer

- A device must be provided in the electrical installation which allows the appliance to be disconnected from the mains at all poles with a contact opening width of at least 3 mm.
Suitable isolation devices are, for example, circuit breakers, fuses (screw-type fuses are to be removed from the holder), earth leakage trips and contactors.
- The installation must guarantee shock protection.
- The stability of the unit in which the appliance is fitted must satisfy the requirements of DIN 68930.
- Built-in ovens and hobs are fitted with special connector systems.
They may only be combined with appliances with a matching system.

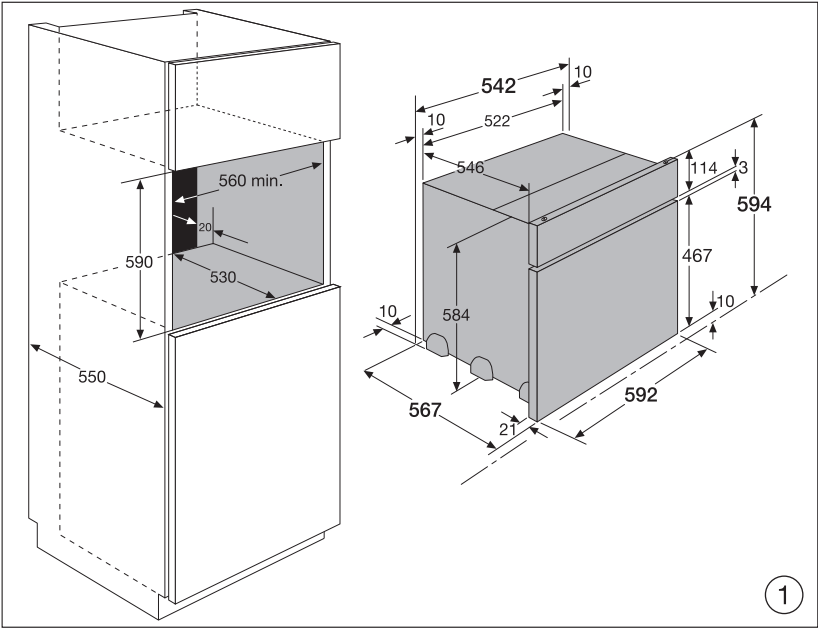

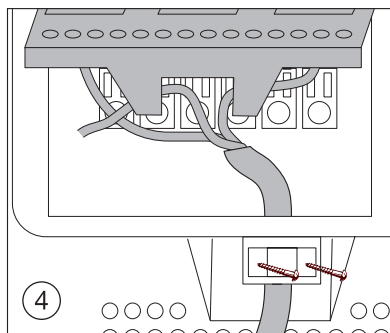
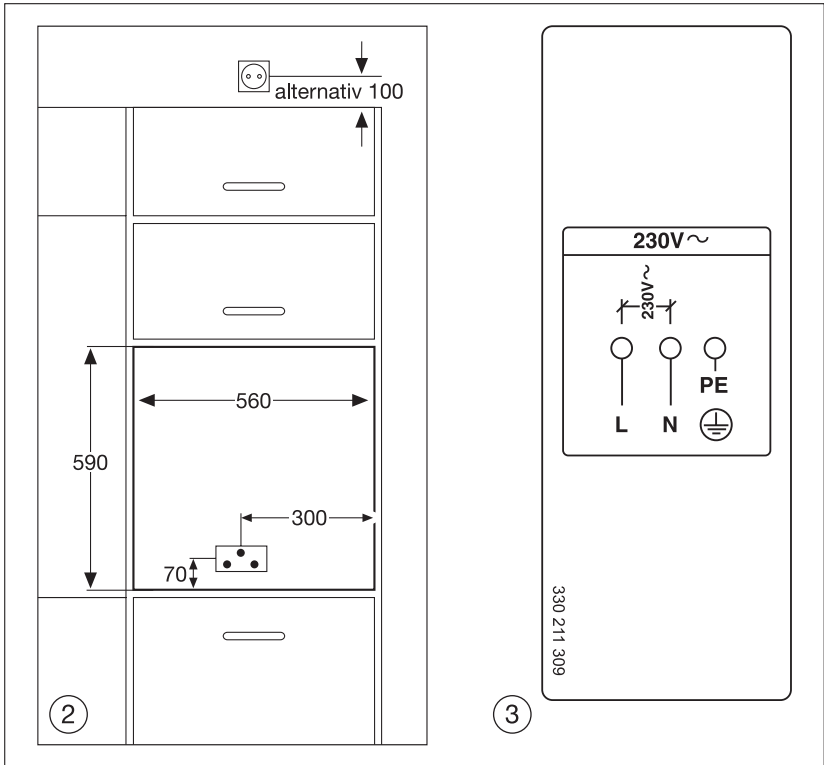

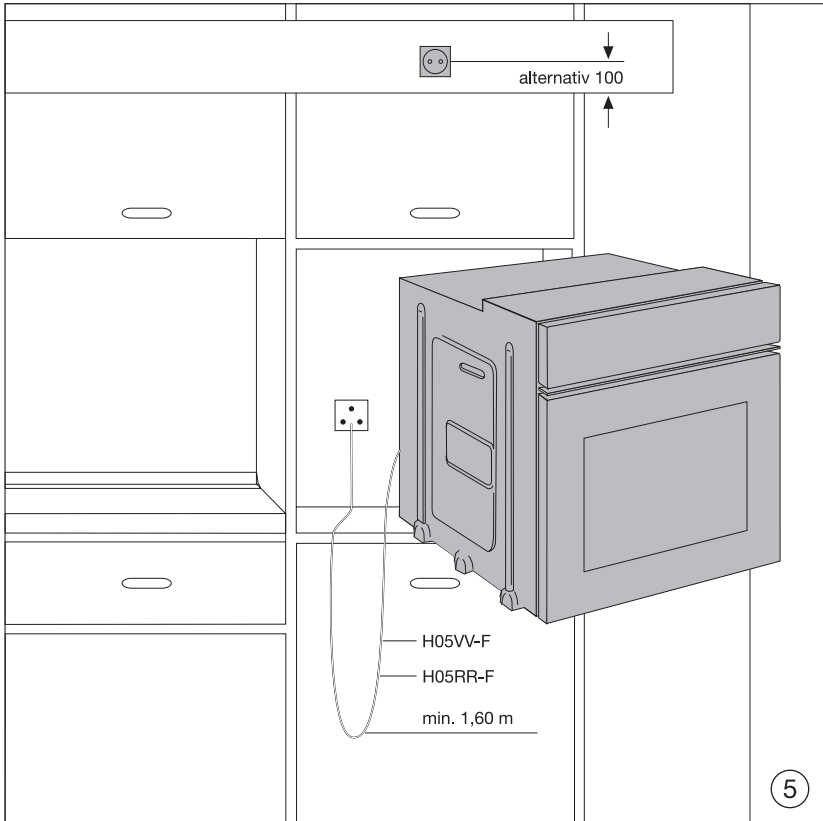

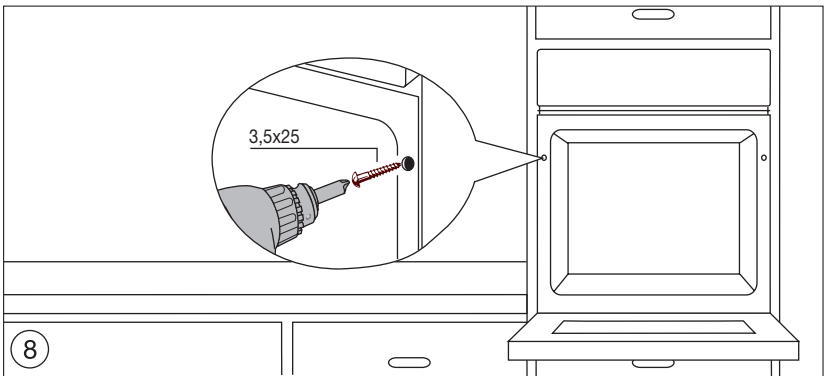
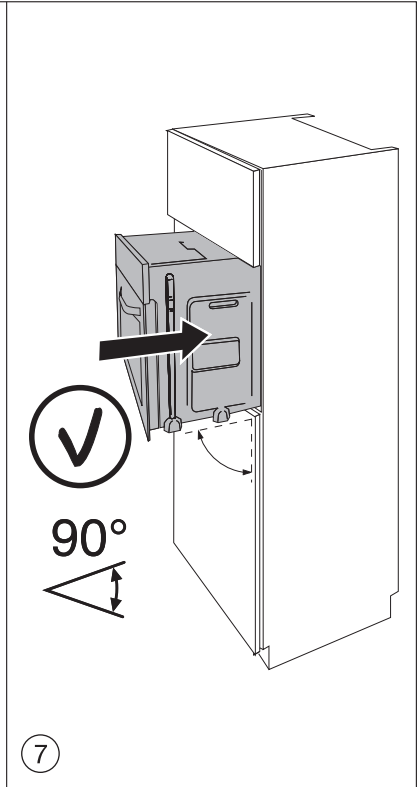
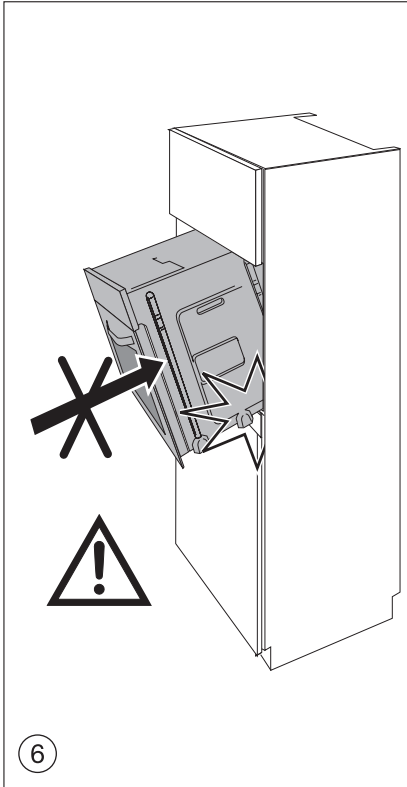

Index

A

- Accessories 9
- Additional functions 23
- All-purpose tray 9

B

- Bakes and Gratin..... 45
- Baking 40
- Baking tray 9
- Bio Functions 56

C

- Child safety device 33
- Cleaning
 - accessories..... 67
 - Cleaning before first use 13
 - Grease filter 67
 - Oven Interior..... 66
 - Side rails 68
 - Steam generation system 70
- Clock 14
 - setting the time 26
- clock display 32
- Clock Functions 26
- Combination shelf 9
- Control panel 8

D

- Defrosting 55
- Description of the appliance..... 7
- Disposal 6
- Drying 54

G

- General purpose tray 20
- grease filter..... 20
- Grilling..... 52

I

- Interval Steam 38

L

- Low Temperature Cooking..... 57

M

- Making preserves 58
- Meat probe 9, 24

O

Oven

- accessories 9
- Bulb..... 71
- functions 15
- operating 14, 17
- Safety cut-out..... 34

R

- Ready Meals..... 46
- Recipes 23, 59
- Repairs 5
- Roasting 48
- Rotitherm..... 15

S

- Safety 5
- Side rails..... 68
- Steam cooking functions 21

T

- Tables and tips..... 35

V

- Vigorous Steam 36

W

- What to do if 74

Service and Spare Parts

If you wish to purchase spare parts or require an engineer, contact your local AEG Service Force Centre by telephoning:

08705 929 929

Your telephone call will be automatically routed to the Service Force Centre covering your post code area.

For the address of your local Service Force Centre and further information about Service Force, please visit the website at

www.serviceforce.co.uk

When you contact the Service Centre they will need the following information:

1. Your name & address, including post code.
2. Your telephone number
3. Clear and concise details of the fault.
4. The model and serial number of the appliance (found on the rating plate).
5. The purchase date:

Please note that a valid purchase receipt or guarantee documentation is required for in-guarantee service calls.

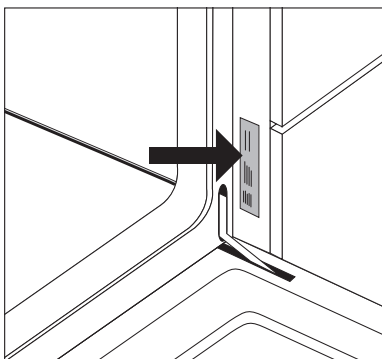

Customer Care

For general enquiries concerning your AEG appliance or for further information on AEG products please contact our Customer Care Department by letter or telephone at the address below or visit our website at **www.aeg.co.uk**.

Customer Care Department
AEG Domestic Appliances
55-77 High Street
Slough
Berkshire, SL1 1DZ

Tel. 08705 350350 (*)

(*) Calls may be recorded for training purposes.

 **From the Electrolux Group. The world's No. 1 choice.**

The Electrolux Group is the world's largest producer of powered appliances for kitchen, cleaning and outdoor use. More than 55 million Electrolux Group products (such as refrigerators, cookers, washing machines, vacuum cleaners, chain saws and lawn mowers) are sold each year to a value of approx. USD 14 billion in more than 150 countries around the world.

AEG Hausgeräte GmbH
Postfach 1036
D-90327 Nürnberg

<http://www.aeg.hausgeraete.de>

© Copyright by AEG

315 6430 13-A-080503-01

Subject to change without notice