



Washing Machine Instruction Manual

DWD-F1011/1012/1013'S/F1211/1212/1213'S

INSTRUCTION MANUAL

Economic wash system

Using artificial intelligence, the washer uses minimum energy and water by selecting optimal water level and washing time.

Low noise system

The washer minimizes the washing and spinning noises by sensing the amount of laundry.

Child-Lock

The Child-Lock system has been used to prevent children from pressing any button to change the program during operation.

Nano-silver sterilization washing(Optional)

By applying very fine silver particles on essential parts inside, the washer sterilizes up to 99.9% as is done by boiling wash.

Air bubble washing(Optional)

This is an advanced technology that generates millions of air bubbles inside the drum on washing sequence, and the bubbles dissolve the detergent particles completely and cleanse all the soil in clothes gently and neatly.

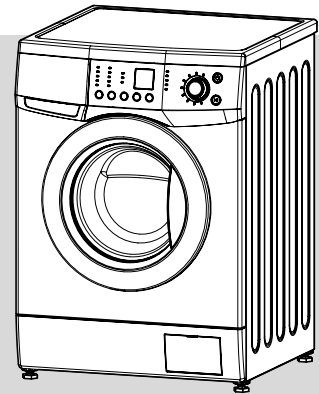

CONTENTS

Page

PARTS AND FEATURES	2
WASHER SAFETY	3
INSTALLATION INSTRUCTIONS	4
INLET HOSE CONNECTION	5
ELECTRICAL REQUIREMENTS	6
OPERATING YOUR WASHER	7
THE FUNCTIONS OF THE CONTROL PANEL	9
WASHING PROCEDURE AND PROGRAM SELECTION	10
MAINTENANCE	19
HOW TO CLEAN THE FILTER	20
REMOVING STAINS	21
TROUBLE SHOOTING	22
SPECIFICATION	23

A NOTE TO YOU

Thank you for buying a DAEWOO appliance.

DAEWOO washers are easy to use, save time, and help you manage your home better.

This manual contains valuable information about how to operate and maintain your washer properly and safely.

Please read it carefully.

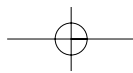

PARTS AND FEATURES

The parts and features of your washer are illustrated on the page. Become familiar with all parts and features before using your washer.

NOTE

The drawings in the book may vary from your washer model. They are designed to show the different features of all models covered by this book, Your model may not include all features.

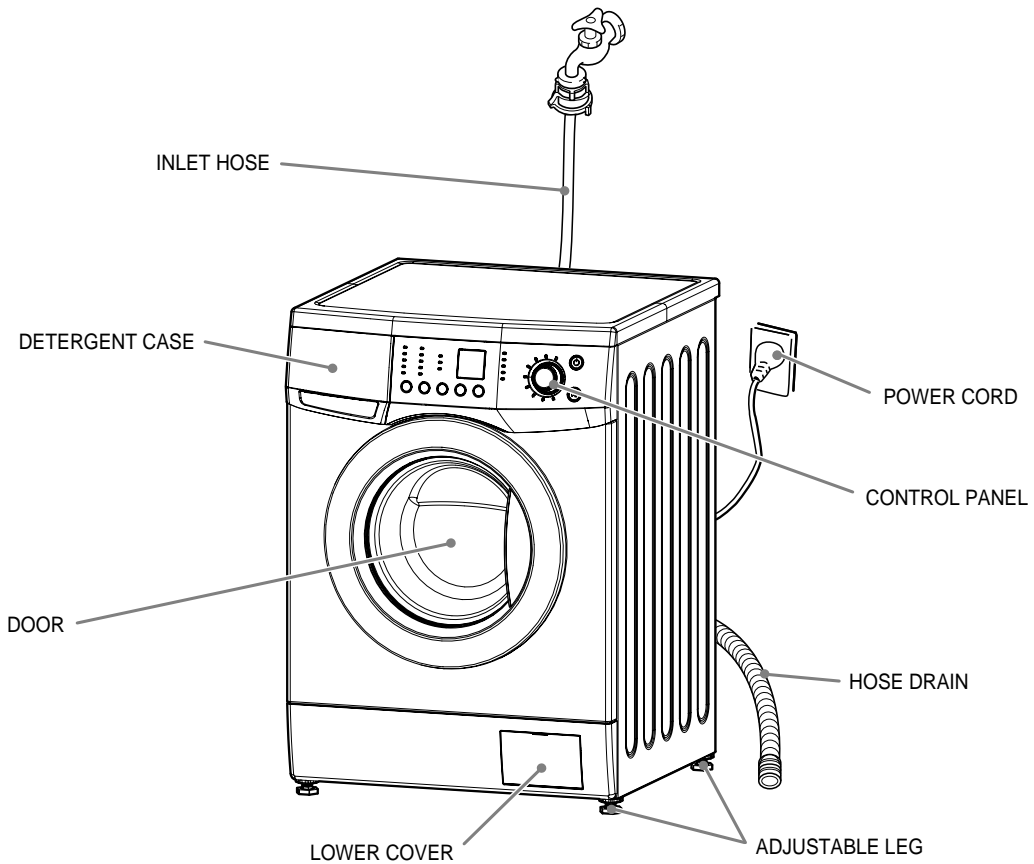

Accessories

Hose drain	Inlet hose	Manual	Cap holder(3EA)

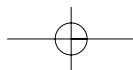

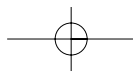

WASHER SAFETY

Save these instructions

Your safety is important to us.

To reduce the risk of fire, electrical shock, or injury when using your washer adhere to the following basic precautions.

Read all instructions before using your washer	
<ul style="list-style-type: none"> • Flammable fluids (dry-cleaning solvents, kerosene, gasoline, etc.) should not be used or stored in or near your washer. Do not add flammable fluids to your wash water. These substances give off vapors that can create a fire hazard or explosion. • After starting a cycle, do not reach into the washer until all motions stop. • Do not tamper with the controls. • The appliance is not intended for use by young children or infirm persons without supervision. • If the supply cord is damaged, it must be replaced by the manufacturer, or its service agent or a similarly qualified person in order to avoid a hazard. • If the appliance is supplied from a cord extension set or electrical portable outlet device it should be positioned so that it is not subjected to splashing or ingress of moisture. 	<p>Please ...</p> <ul style="list-style-type: none"> • Have only a qualified person install, repair, or replace parts on washer. • Maintain washer properly. • Protect washer from the weather and keep it where the temperature will not fall below freezing. • Do not install the washer at a place of extremely high humidity. It could cause an electric shock or a short circuit. • Connect washer to the correct outlet, electrical supply, water supply, and drain supply.

Understanding your responsibilities

- Do not use chlorine bleach and ammonia or acid (such as vinegar or rust remover) in the same wash. Hazardous fumes can form.
- Unplug power supply cord before attempting to service your washer.
- Do not wash fiberglass material.
Small particles can stick to fabrics washed in following loads and cause skin irritation.
- Do not spray water on the control panel of the washer.
It could cause fire or an electric shock.
- In case of the dual valve model, if you connect only cold water inlet valve, while water temperature is selected as hot or warm, there can be water leakage from unconnected water inlet valve.
- This appliance must be grounded.
To avoid electrical shock, use a metal pipe for the ground connection.

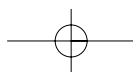

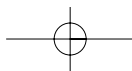

INSTALLATION INSTRUCTIONS

Removing transit bolts

1. Before operating the washer, remove the transit bolts(3ea) along with the rubber.
 - If the bolts are not removed, it may cause heavy vibration, noise and malfunction.

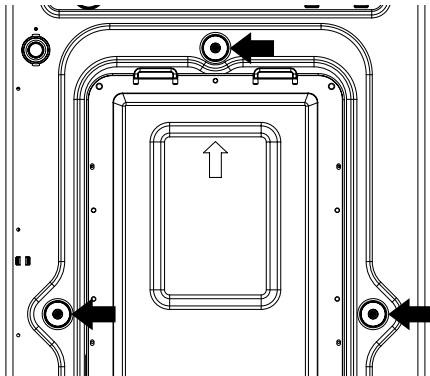

2. Unscrew the 3 bolts with the 10mm hex wrench or spanner or cross-tip screwdriver. Keep the 3 bolts for a later time.

- When the appliance is transported, transit bolts will be re-used.

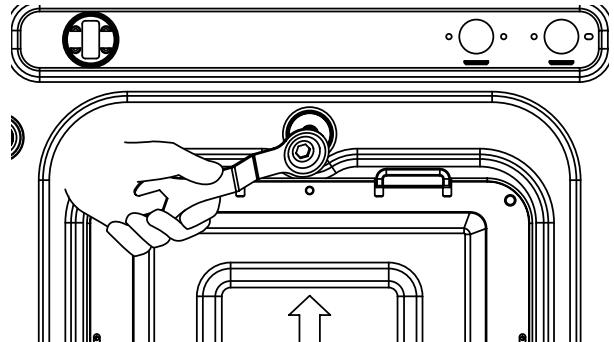

3. Close the holes with the cap holders supplied.

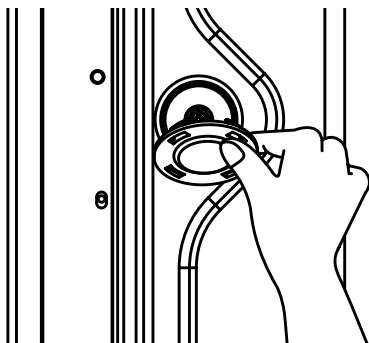

Location of washer

- Check location where the washer will be installed. Make sure you have everything necessary for correct installation.
- Do not place or store your washer below 0°C (32°F) to avoid any damage from freezing.
- Do not place or store laundry products on top of washer at any times.
- Install the washer on the horizontal solid floor.

If the washer is installed on an unsuitable floor, it could make considerable noise, vibrate severely and cause a malfunction. If the washer is not level, adjust leg up or down for horizontal installation.
- Ventilation openings must not be obstructed by carpeting when the washer is installed on a carpeted floor.
- Leave some space (right & left : 2cm, rear : 10cm).
- In case of built-in installation, the distance between top of the washer and bottom of upper plate should be at least 3mm.

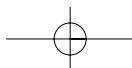
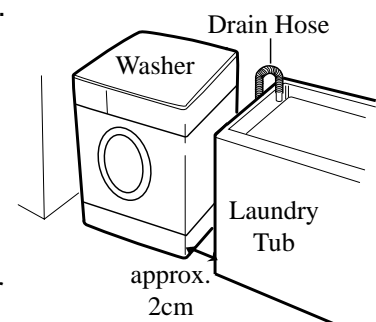

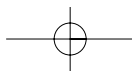

INLET HOSE CONNECTION

The washer should be connected to the water mains using new hose sets and old hose sets should not be reused.



In using only one water tap or in case of only one water inlet valve, connect the inlet hose to the cold water inlet valve.

Option : Be careful not to confuse hot water inlet and cold water inlet.

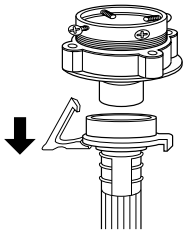
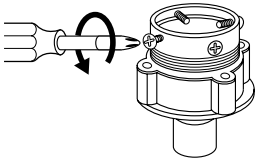
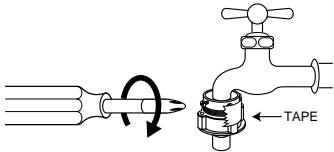
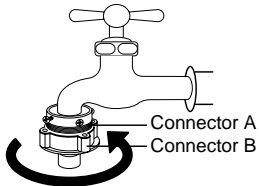
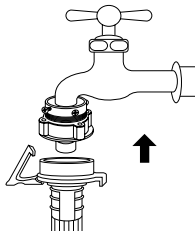
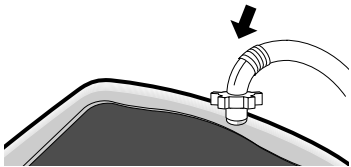
For Ordinary Tap

<p>① Pull down the collar of the inlet hose to separate it from the water tap adapter.</p> 	<p>② Loosen the four screws properly in order to fit into water tap.</p> 	<p>③ Fit the water tap adapter into the water tap and tighten the four screws evenly while pushing up the adapter so that the rubber packing can stick to the water tap tightly.</p> 
<p>④ Remove the tape, and screw connector B into connect A tightly.</p> 	<p>⑤ Connect the inlet hose to the water tap adapter by pulling down the collar of the hose end.</p> 	<p>⑥ Connect the inlet hose adapter of the hose to the water inlet of the washer by turning it clockwise to be fixed tightly.</p>  <p>• Please check the rubber packing present inside the inlet hose adapter of the hose.</p>

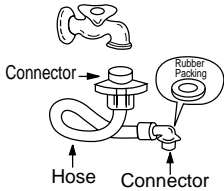
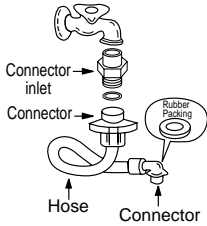
For Screw-Shaped Tap

<p>① Connect the inlet hose to the water tap by screwing the connector tightly.</p> 	<p>② Connect the connector-inlet supplied if necessary.</p> 	<p>③ Connect the inlet hose adapter to the water inlet of a washer and turn it to be fixed.</p>  <p>*Check the packing in the inlet</p>
---	---	--

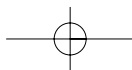

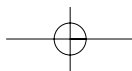

ELECTRICAL REQUIREMENTS

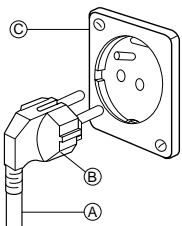
WARNING	Electrical shock hazard : Failure to follow these instructions could result in death or serious injury.	
<ul style="list-style-type: none"> • Electrical earth is required on this washer • If it does not fit the outlet, have a proper outlet installed by a qualified electrician. 	<ul style="list-style-type: none"> • Don't earth to a gas pipe. • Don't change the power supply cord plug. • Check with a qualified electrician if you are not sure the washer is properly earthed. 	
Recommended earthing method		
	<p>For your personal safety, this washer must be earthed.</p> <p>This washer is equipped with a power supply cord 'A' having an earthing plug 'B'. To minimize possible shock hazard, the cord must be plugged into a mating earthing-type wall receptacle 'C'. If a mating wall receptacle is not available, it is the personal responsibility and obligation of the customer to have the proper earthed wall receptacle installed by a qualified electrician.</p>	

Drain system

- Never forget to install drain hose before operating your washer.
- Open the packing box, and there is a drain hose inside the drum.
- Connect the drain hose to the drain outlet at the back side of the washer.
- Top of laundry tub must be at least 60cm high and no higher than 100cm from bottom of washer.

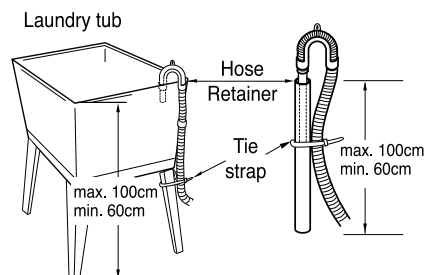
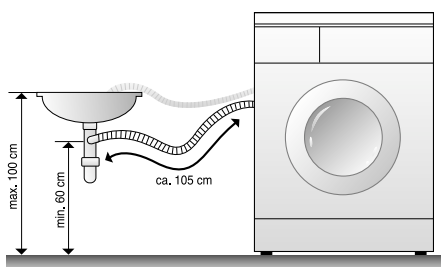

- When installing the drain hose to tub(sink), secure it tightly with a string.
- Proper securing of the drain hose will protect the floor from damage due to water leakage.
- When the drain hose is too long, do not force it back into the washer. This will cause abnormal noise.

Level adjustment

- ① If the washer is installed on an unsuitable floor, it could make considerable noise, vibrate and cause a malfunction.

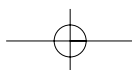

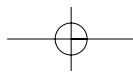

② Adjust the level of washer using adjustable legs.

- Please check if there is any gap between the four adjustable legs and the floor.
- Adjust the level of washer by turning adjustable legs. And make it sure that there is no swaying of washer.
- After the adjustment is finished, turn the fixing nuts up tightly so that the washer maintains the adjustment.

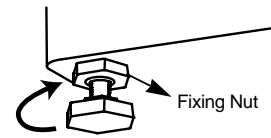
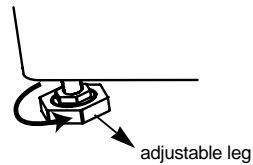

③ Make it sure that the washer does not sway when you press down the four corners of the washer's top plate.

NOTE

There should be no swaying of washer and all the adjustable legs should stick to the floor closely.

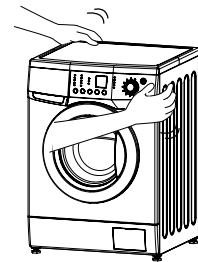

OPERATING YOUR WASHER

To obtain the best washing results, you must operate your washer properly. This section gives you this important information.

Preparing clothes for washing

- | | |
|--|--|
| <ul style="list-style-type: none"> • Close zippers, snaps, and hooks to avoid snagging other items. Remove pin, buckles, and other hard objects to avoid scratching the washer interior. • Empty pockets and pull them inside out. | <ul style="list-style-type: none"> • Turn down cuffs and turn synthetic knits inside out to avoid pilling. • Tie strings and sashes to avoid tangling. • Treat spots and stains. (See "Removing stains" on page 21) |
|--|--|

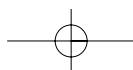
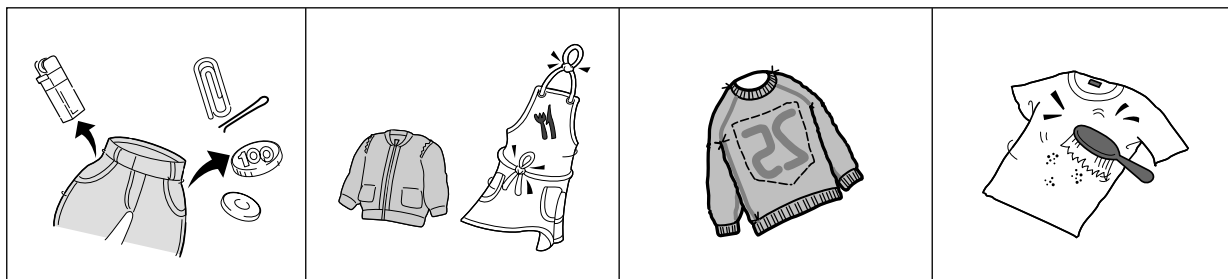

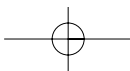

Sorting

- Separate heavily soiled items from lightly soiled ones, even if they would normally be washed together.
- Separate dark colors from light colors, colorfast items from non-colorfast item.

Soil (Heavy, Normal, Light)
Color (White, Lights, Darks)
Lint (Lint producers, Collectors)

Separate clothes according to amount of soil.
Separate white clothes from colored clothes.
Wash lint producers and lint collectors separately.

Loading

- Drop items into washer loosely. Items should move easily through wash water for best cleaning and wrinkle-free results.
- Load washer properly and select correct load size setting.
Overloading and selecting a setting too small for the wash load can :
 - Cause poor cleaning
 - Increase wrinkling
 - Create excessive lint
 - Wear out items faster (because of pilling)

- Mix large and small items in each load. Load evenly to maintain washer balance.
An unbalanced load can make the washer vibrate during spin.
- Reduce wash time when using a small load size setting. Load with only a few small items needs less wash time.
- Use a large load size setting to reduce wrinkling with permanent press clothes and some synthetic knits. These items should have more room to move in the water than heavy items. (towels, jeans)

Adding detergent

① Detergent case

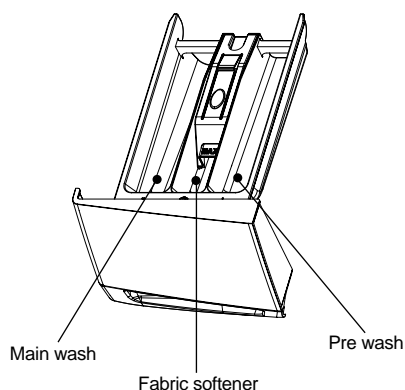

② Adding fabric softener

- If desired, add measured liquid fabric softener to the softener inlet.
- Pour liquid fabric softener into the dispenser using the amount recommended on the package.
- Do not exceed the maximum fill line.
Overfilling can cause early dispensing of the fabric softener which could stain clothes.
- Do not open the detergent case when water is supplied.
- Avoid pouring fabric softener directly on the clothes.



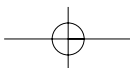

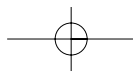

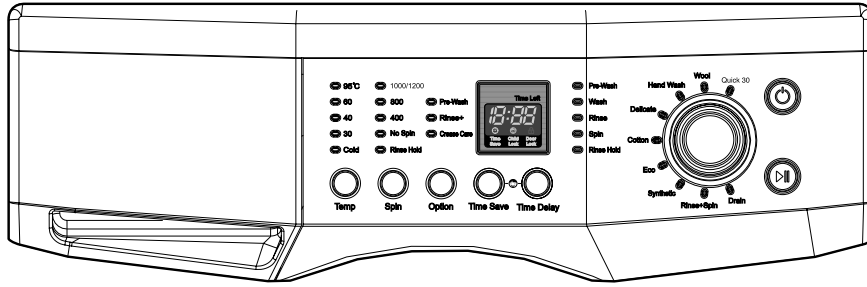

- Please use only the powder detergent for the front loader washing machine.
- Please use the proper amount of detergent in conformity with the instruction of the detergent manufacturer.
- A use of a large amount of detergent more than the recommended amount can cause many soapsuds and the overload to the motor. In addition to, this will deteriorate the washing and rinse performance.





THE FUNCTIONS OF THE CONTROL PANEL

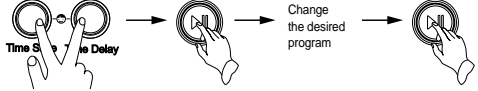

 Power	Press this switch to turn the power on or off.
 Start/Hold	Operation and temporary stop is repeated as it is pressed. When you want to change program in operating; press the "Start/Hold" button Select the program that you want to change press the "Start/Hold" button again.
	You can select the course you want, and each lamp is turned on when that course is selected. For the more detailed information, please refer to the page 11~18.
 Temp	It can be used to adjust temperature of water according to types of the load to be washed. As the button is pressed, temperature of water is selected by Cold 30°C 40°C 60°C 95°C
 Spin	By pressing the spin button, the spin speed can be chosen. Rinse Hold <ul style="list-style-type: none"> • Is selected by pressing the spin button repeatedly. This function leaves clothes in the machine; suspended in the water after a rinse without entering into spin. • To proceed through to a drain or spin, after the Rinse Hold function is completed, use spin button. No spin <ul style="list-style-type: none"> • If no spin is selected, the washer stops after draining water. Spin only <ul style="list-style-type: none"> • If you want only spin, you can operate spin only. (See page 18.)
 Option	Crease Care <ul style="list-style-type: none"> • If you want to prevent crease, select this button with spin speed. Rinse+ <ul style="list-style-type: none"> • Is used to add a rinse, which may assist in removing traces of detergent residue. • By selecting Rinse+ function, the rinse time and the rinse water are increased. Pre-Wash <ul style="list-style-type: none"> • The washer operates one additional wash and spin before the main wash. • If the laundry is heavily soiled, Pre-Wash course is effective. • Pre-Wash is available in Cotton and Synthetic programs.
 Time Save	All courses have pre-set washing times, but Time Save decreases it to 10 minutes. Each time this button is pressed the watch icon is repeated on and off. When it is on, the Time Save function is set. Time Save is available in Cotton, Eco and Synthetic programs.
 Time Delay	It can be used to pre-engage time for wash.
 Time Save Time Delay	Use this function when you want to protect any accident occurring from handling of washer by a child. During an operation of washer, press 'Time Save' and 'Time Delay' buttons simultaneously. In Child Lock mode, no button functions except Power button. In Child Lock mode, press 'Time Save' and 'Time Delay' buttons simultaneously like setting Child Lock and Child Lock is cancelled. To change to the desired program, while in Child Lock mode; 1. Press both the Time save and Time delay buttons together once again. 2. Press the Start/Hold button. 3. Select the desired program and press the Start/Pause button again.  <p style="text-align: right;">Change the desired program</p> <p>* The Child Lock will be cancelled when power is off.</p>

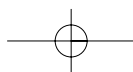

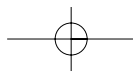

WASHING PROCEDURE AND PROGRAM SELECTION

1. COTTON IS AUTOMATICALLY SELECTED UPON POWER ON

- Press the Power button to start.
- Press the Start/Hold button
- Initial condition
 - Program : Cotton
 - Wash : main wash
 - Rinse : 3 times
 - Spin : 800 rpm
 - Water temperature : 40°C

2. MANUAL SELECTING

- Press the Power button to start
- Select the conditions which you want to use by turning the program dial and pressing each button.
- Press the Start/Hold button.

3. RESERVED WASHING

- Reservation can be made from 2 hours to 12 hours.
example) To make reservation to complete washing in 8 hours.
- Procedure to press the button.

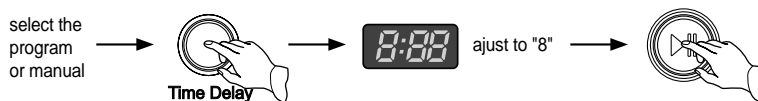

- * Each pressing of the button advances time delay by one hour.
- Now the reservation is made.
- If you want to check the selected program, press the "Start/Hold" button again.
- Preparing washing before starting "Time Delay";
 - Turn on the water tap
 - Load laundry and close the door
 - Place the detergent and fabric softener in the detergent case.
- To cancel the time delay, press the Power button.

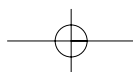

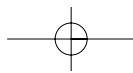

4. FUNCTION

- Recommended programs according to the laundry type

Program	Fabric Type	Proper Temp.	Option	Maximum Load
Cotton	First check if laundry is machine washable.(white cotton, linen towel and sheets..)	60°C (95°C)	Pre Wash Rinse+ Crease Care	Rating
	Colorfast garments (shirts, night dresses, pajamas..) and lightly soiled white cottons (underwear..)	40°C (60°C, 30°C)	Pre Wash Rinse+ Crease Care	Rating
Eco	Laundry type is the same as Cotton.	60°C	Pre Wash Rinse+ Crease Care	Rating
Synthetic	Polyamide, Acrylic, Polyester	40°C (60°C, 30°C)	Pre Wash Rinse+ Crease Care	Less than 1.5kg
Delicate	Delicate laundry easily damaged (silk, curtains..)	Cold	Rinse+ Crease Care	Less than 1.0kg
Wool	Machine washable woolens with pure new wool only.	Cold	Rinse+ Crease Care	Less than 1.0kg
Hand Wash	“Hand wash” marked delicate and wool laundry	Cold (30°C)	Rinse+ Crease Care	Less than 1.0kg
Quick	Colored laundry which is lightly soiled fast.	30°C (Cold, 40°C)	Rinse+ Crease Care	Less than 1.0kg

- Pre Wash : If the laundry is heavily soiled, “Pre Wash” program is recommended.
Pre Wash is available in Cotton and Synthetic programs.
- Rinse+ : Used to introduce an additional rinse, which may assist in removing traces of detergent residue.
- Eco : By selecting Eco function, the water temperature is lowered and washing time is increased.
So you can economize your consumption of heating energy.

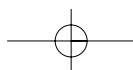

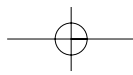

* COTTON PROGRAM

1	<p>Put the laundry in to the drum. Put detergent and softener into the detergent case. Then close the door.</p> <ul style="list-style-type: none"> • Put detergent into the main wash and prewash compartments in the detergent case. Softener should be below the 'MAX' level. • Put detergent into the pre wash compartment only if you want to add prewash. • When you want to use bleach, put it into the main wash compartment with detergent.
2	<p>Press the Power button.</p> <ul style="list-style-type: none"> • The LED shows only '---' and all Program Lights turn on.
3	<p>Select the 'Cotton' program using program selection dial.</p> <ul style="list-style-type: none"> • If you press Start/Hold button after power button without selecting program, the 'Cotton' program is selected as default program. • Washing temperature '40' °C, spin '800' rpm and rinse '3' times are selected automatically. • If you want to change washing temperature, the spin velocity or add wash options (Rinse+, Crease Care), press each button.
4	<p>Press Start/Hold button.</p> <ul style="list-style-type: none"> • The Door is locked. By sensing the weight of laundry and supplying wash water, The appliance starts washing.

Note

- If you want to change the setting during operation, press the Start/Hold button to hold the operation and press the button you want.
- '30', '40', '60' and '95' °C washing temperatures are selectable with Cotton program.
- 'Prewash', 'Rinse+', and 'Crease Care' wash options are selectable with Cotton program.

Caution!

- If you select washing temperature '95' °C, some cold water is supplied before the drain of main wash. This is to protect the user from the hazard of burn injury by lowering the temperature of hot wash water instead of directly draining it. Therefore this is not a malfunction.
(Be careful with the draining water, since it can be still hot although the temperature is lowered.)

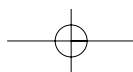

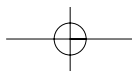

* ECO PROGRAM

1	<p>Put the laundry in the drum. Put detergent and softener into the detergent case. Then close the door.</p> <ul style="list-style-type: none"> • Put detergent into the main wash and prewash compartments in the detergent case. Softener should be below the 'MAX' level. • Put detergent into the pre wash compartment only if you want to add prewash. • When you want to use bleach, put it into the main wash compartment with detergent.
2	<p>Press the Power button.</p> <ul style="list-style-type: none"> • The LED shows only '---' and all Program Lights turn on.
3	<p>Select the 'Eco' program using program selection dial.</p> <ul style="list-style-type: none"> • Washing temperature '60' °C, spin '800' rpm and rinse '3' times are selected automatically. • If you want to change the spin velocity or add wash options (Rinse+, Crease Care), press each button.
4	<p>Press Start/Hold button.</p> <ul style="list-style-type: none"> • The Door is locked. By sensing the weight of laundry and supplying wash water, The appliance starts washing.

Note

- If you want to change the setting during operation, press the Start/Hold button to hold the operation and press the button you want.
- Only '60' °C washing temperature is selectable with Eco program.
- Only 'Rinse+' and 'Crease Care' of all wash options are selectable with Eco program.

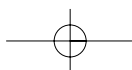

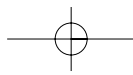

* SYNTHETIC PROGRAM

1	<p>Put the laundry in the drum. Put detergent and softener into the detergent case. Then close the door.</p> <ul style="list-style-type: none"> • Put detergent into the main wash and prewash compartments in the detergent case. Softener should be below the 'MAX' level. • Put detergent into the pre wash compartment only if you want to add prewash. • When you want to use bleach, put it into the main wash compartment with detergent.
2	<p>Press the Power button.</p> <ul style="list-style-type: none"> • The LED shows only '---' and all Program Lights turn on.
3	<p>Select the 'Synthetic' program using program selection dial.</p> <ul style="list-style-type: none"> • Washing temperature '40' °C, spin '800' rpm and rinse '3' times are selected automatically. • If you want to change washing temperature, the spin velocity or add wash options (Prewash, Rinse+, Crease Care), press each button.
4	<p>Press Start/Hold button.</p> <ul style="list-style-type: none"> • The Door is locked. By sensing the weight of laundry and supplying wash water, The appliance starts washing.

Note

- If you want to change the setting during operation, press the Start/Hold button to hold the operation and press the button you want.
- Only '30', '40' and '60' °C washing temperatures are selectable with Synthetic program.
- 'Prewash', 'Rinse+', and 'Crease Care' wash options are selectable with Synthetic program.
- The appropriate amount of laundry for Synthetic program is below 1.5kg.

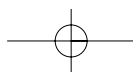

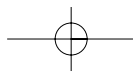

* DELICATE PROGRAM

1	<p>Put the laundry in the drum. Put detergent and softener into the detergent case. Then close the door.</p> <ul style="list-style-type: none"> • Put detergent into the main wash and prewash compartments in the detergent case. Softener should be below the 'MAX' level. • Put detergent into the pre wash compartment only if you want to add prewash. • When you want to use bleach, put it into the main wash compartment with detergent.
2	<p>Press the Power button.</p> <ul style="list-style-type: none"> • The LED shows only '---' and all Program Lights turn on.
3	<p>Select the 'Delicate' program using program selection dial.</p> <ul style="list-style-type: none"> • Washing temperature 'Cold', spin '400' rpm and rinse '2' times are selected automatically. • If you want to change the spin velocity or add wash options (Rinse+, Crease Care), press each button.
4	<p>Press Start/Hold button.</p> <ul style="list-style-type: none"> • The Door is locked. By sensing the weight of laundry and supplying wash water, The appliance starts washing.

Note

- If you want to change the setting during operation, press the Start/Hold button to hold the operation and press the button you want.
- Only 'cold' of washing temperature is selectable with Delicate program.
- '1000' rpm of spin velocity is NOT selectable with Delicate program.
- Only 'Rinse+' and 'Crease Care' wash options are selectable with Delicate program.
- The appropriate amount of laundry for Delicate program is below 1.0kg.

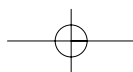

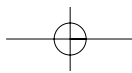

* WOOL PROGRAM

1	<p>Put the laundry in the drum. Put detergent and softener into the detergent case. Then close the door.</p> <ul style="list-style-type: none"> • Put detergent into the main wash and prewash compartments in the detergent case. Softener should be below the 'MAX' level. • Put detergent into the pre wash compartment only if you want to add prewash. • When you want to use bleach, put it into the main wash compartment with detergent.
2	<p>Press the Power button.</p> <ul style="list-style-type: none"> • The LED shows only '---' and all Program Lights turn on.
3	<p>Select the 'Wool' program using program selection dial.</p> <ul style="list-style-type: none"> • Washing temperature 'Cold', spin '400' rpm and rinse '2' times are selected automatically. • If you want to change the spin velocity or add wash options (Rinse+, Crease Care), press each button.
4	<p>Press Start/Hold button.</p> <ul style="list-style-type: none"> • The Door is locked. By sensing the weight of laundry and supplying wash water, The appliance starts washing.

Note

- If you want to change the setting during operation, press the Start/Hold button to hold the operation and press the button you want.
- Only 'Cold' washing temperature is selectable with Wool program.
- '1000' rpm of spin velocity is NOT selectable with Hand program in order to protect damage on laundry.
- Only 'Rinse+' and 'Crease Care' wash options are selectable with Wool program.
- The appropriate amount of laundry for Wool program is below 1.0kg.
- Use only special detergent for wool.
(Since special neutral detergent for wool creates a lot of bubbles, use appropriate amount).

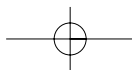

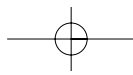

* HAND WASH

1	<p>Put the laundry in the drum. Put detergent and softener into the detergent case. Then close the door.</p> <ul style="list-style-type: none"> • Put detergent into the main wash and prewash compartments in the detergent case. Softener should be below the 'MAX' level. • Put detergent into the pre wash compartment only if you want to add prewash. • When you want to use bleach, put it into the main wash compartment with detergent.
2	<p>Press the Power button.</p> <ul style="list-style-type: none"> • The LED shows only '---' and all Program Lights turn on.
3	<p>Select the 'Hand Wash' program using program selection dial.</p> <ul style="list-style-type: none"> • Washing temperature 'Cold', spin '400' rpm and rinse '3' times are selected automatically. • If you want to change the washing temperature, spin velocity or add wash options (Rinse+, Crease Care), press each button.
4	<p>Press Start/Hold button.</p> <ul style="list-style-type: none"> • The Door is locked. By sensing the weight of laundry and supplying wash water, The appliance starts washing.

Note

- If you want to change the setting during operation, press the Start/Hold button to hold the operation and press the button you want.
- Only 'Cold' and '30' °C washing temperatures are selectable with Hand Wash program.
- '1000' rpm of spin velocity is NOT selectable with Hand program.
- Only 'Rinse+' and 'Crease Care' wash options are selectable with Hand Wash program.
- Use Hand Wash program for the laundry that is marked 'Hand wash' in the care label.

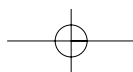

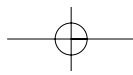

* QUICK 30

1	<p>Put the laundry in the drum. Put detergent and softener into the detergent case. Then close the door.</p> <ul style="list-style-type: none"> • Put detergent into the main wash and prewash compartments in the detergent case. Softener should be below the 'MAX' level. • Put detergent into the pre wash compartment only if you want to add prewash. • When you want to use bleach, put it into the main wash compartment with detergent.
2	<p>Press the Power button.</p> <ul style="list-style-type: none"> • The LED shows only '---' and all Program Lights turn on.
3	<p>Select the 'Quick' program using program selection dial.</p> <ul style="list-style-type: none"> • Washing temperature '30' °C, spin '800' rpm and rinse '2' times are selected automatically. • If you want to change the washing temperature, spin velocity or add wash options (Rinse+, Crease Care), press each button.
4	<p>Press Start/Hold button.</p> <ul style="list-style-type: none"> • The Door is locked. By sensing the weight of laundry and supplying wash water, The appliance starts washing.

Note

- If you want to change the setting during operation, press the Start/Hold button to hold the operation and press the button you want.
- Only 'Cold', '30' °C and '40' °C washing temperatures are selectable with Quick 30 program.
- Only 'Rinse+' and 'Crease Care' wash options are selectable with Quick 30 program.

* SPIN ONLY

1	Put the laundry in the drum. Then close the door.
2	<p>Press the Power button.</p> <ul style="list-style-type: none"> • The LED shows only "--" and all Program Lights turn on.
3	Select the spin speed by pressing Spin button.
4	<p>Press the Start/Hold button.</p> <ul style="list-style-type: none"> • The washing machine will start operating by locking the door.

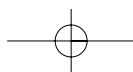

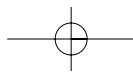

MAINTENANCE

Proper care of your washer can extend its life. This section explains how to care for your washer properly and safely.

Cleaning your washer

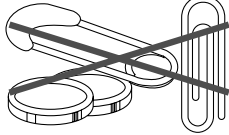
Exterior	Interior
<p>Wipe up detergent, bleach, and other spills with a soft, damp cloth or sponge as they occur. Occasionally wipe the outside of the washer to keep its looking like new one.</p> 	<p>Clean interior with 250ml of chlorine bleach mixed with 500ml of detergent. Run washer through a complete cycle. Repeat this process if necessary.</p>
<p>Do not put sharp or metal object in your washer, or they can damage the finish. Check all pockets for pins, clips, money, bolts, nuts, etc. Do not lay these objects in your washer after emptying pockets.</p> 	

Winter storage or moving care

Install and store your washer where it will not freeze. Because some water may stay in the hoses, freezing can damage your washer.

If you store or move your washer during freezing weather, winterize it.

To winterize washer	To use washer again
<ul style="list-style-type: none"> • Turn off water faucet. • Disconnect and drain water inlet hoses. • Run washer on a drain and spin setting (see page 10) for 1 minute. • Unplug the power supply cord. 	<ul style="list-style-type: none"> • Flush water pipes and hoses. • Reconnect water inlet hoses. • Turn on water faucet. • Reconnect power supply cord.

Non-use or vacation care

Operate your washer only when you are at home.

If you are on vacation or don't use your washer for an extended period of time, you should:

- Unplug the power supply cord or turn off electrical power to the washer.
- Turn off the water supplier to the washer.

This helps avoid accidental flooding (due to a water pressure surge) while you are away.

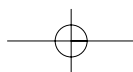

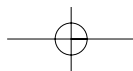

HOW TO CLEAN THE FILTER

Cleaning the water inlet filter

- Clean the filter when water leaks from the water inlet.

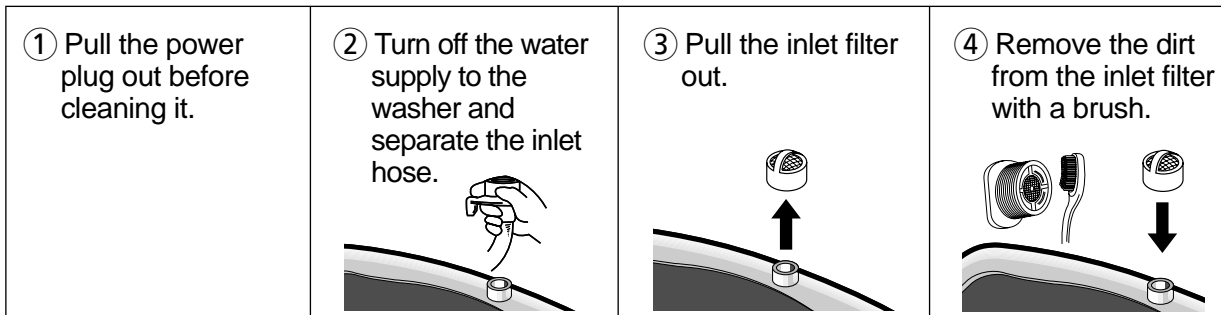

Cleaning the drain filter

- This drain filter is used to screen the foreign stuffs such as threads, coins, pins, buttons etc..
- If the drain filter is not cleaned at proper time (every 10 times of use), drain problem could be caused.

CAUTION : Be careful when draining if the water is hot.

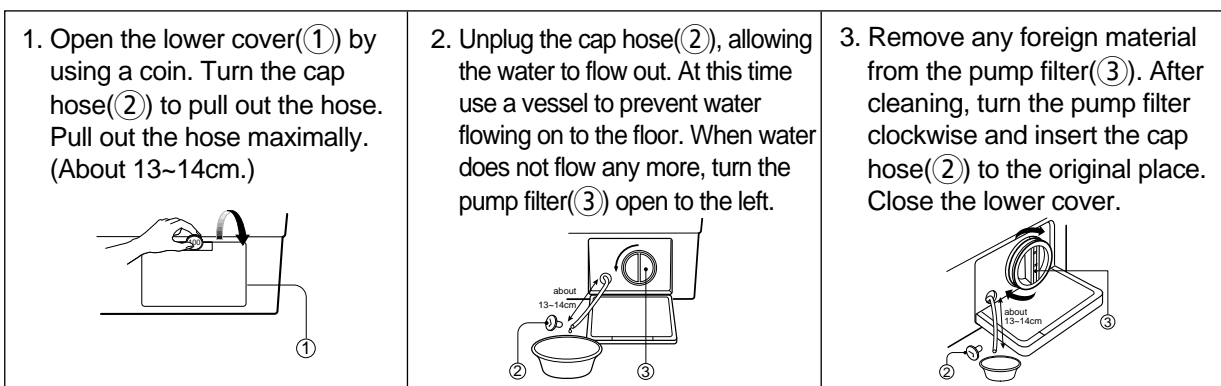

Cleaning the detergent case

*After a while detergent and fabric softeners leave a deposit in the case;

- It should be cleaned from time to time with a jet of running water.
- If necessary it can be removed completely from the machine by pressing the catch downwards and by pulling it out.
- To facilitate cleaning, the upper part of the fabric softener compartment can be removed.

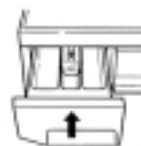
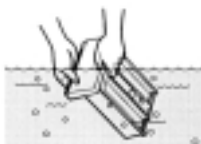
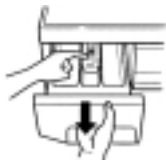

*Detergent can also accumulate inside the recess which should be cleaned occasionally with a brush.

*Once you have finished cleaning, replace the case and run a rinse cycle without laundry.

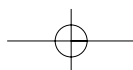

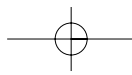

REMOVING STAINS

Stained, heavily-soiled, or greasy items may need to be prewashed or soaked for best results. Soaking helps remove protein-type stains like blood, milk or grass. Prewashing helps loosen soil before washing.

Stain removal rules

- Use warm water for soaking or prewashing stained laundry. Hot water can set stains.
- Most stains are easier to remove when they are fresh.
- Before treating any stain, find out what kind of stain it is, how old the stain is, what kind of fabric it is, and whether the fabric is colorfast. (Check the care label)
- Washing and drying can set some stains.
- Start with cold or warm water. Hot water can set some stains.
- When bleach is recommended, use a bleach that is safe for the fabric.
- Put the stained area face down on a paper towel or white cloth. Apply the stain remover to the back of the stain. This forces the stain off fabric instead of through it.

Stain removal guide

STAIN	TO REMOVE
Blood	Rinse immediately in COLD water. If stain remains, soak in cold water with an enzyme prewash.
Chewing gum	Use ice in plastic bag to harden the gum. Scrape off what you can and the sponge with white spirits.
Cocoa, Chocolate	Sponge with COLD water and soak in an enzyme prewash. If stains persist, rub in a little detergent and rinse in cold water.
Coffee	Blot up quickly and rinse out in COLD water. Rub in a little detergent and wash in the maximum temperature allowed for the fabric type.
Cream/Milk Ice cream	Rinse in COLD water and wash normally. If stain is still apparent, sponge with white spirits.
Deodorant	Rub affected area with white vinegar and then rinse out in COLD water. Sponge with white spirits. Treat stiffened areas with enzyme prewash.
Egg	Soak in a COLD enzyme prewash, rinse and wash normally.
Fabric/Softener	Rub affected area with bar soap and wash normally.
Fruit stains	Treat as soon as possible by sponging with COLD water. Rub a little detergent on the stain and wash normally.
Grass	Sponge with white spirits. Rub in an enzyme prewash and wash as normally.
Grease and oil	Lay the affected area face down on an absorbent cloth and work from the back. Sponge with white spirits or dry cleaning fluid. Wash normally.
Iron or rust	Apply lemon juice and salt and place in the sun. Wash normally.
Lipstick	Sponge with white methylated spirits and wash normally.
Mildew	Wash in WARM water and detergent. Moisten area with lemon juice, dry in the sun and wash normally. If stain persists and the fabric allows, use a bleach.
Mud	Brush off any dry mud. Rinse in cold water. If stain persists rub in a little detergent and wash normally.
Paint-oil based	Scrape off any fresh paint and sponge with a non flammable dry cleaning fluid and wash normally.
Paint-water based	Treat while still wet, rinse in WARM water and wash normally.
Scorch marks	Dampen a cloth with hydrogen peroxide, lay it over the affected area and press with a fairly hot iron.

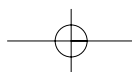

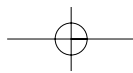

TROUBLE SHOOTING

Most problems are easily solved if you understand the cause.

Check the following list for problem before calling for service.

If the error mode such as IE, OE, UE were displayed on the control part, in order to solve these problem, first turn off the power of the washing machine and then turn on the power pressing Power button.

If PFE error mode was displayed on the control part, in order to solve this problem, first turn off the power of the washing machine, second turn on the power pressing Power button, third press SPIN button and last press Start/Hold button.

PROBLEM	CHECK POINT
<ul style="list-style-type: none"> The washer will not operate at all. 	<ul style="list-style-type: none"> Is there a power failure? Is the power cord correctly connected to an electric outlet? Did you turn on the power? Did you press Start/Hold button? Is there correct amount of laundry in the washer?
<ul style="list-style-type: none"> Water is not supplied <p>Error display IE</p>	<ul style="list-style-type: none"> Did you connect the inlet hose and open the water tap? Is the inlet hose or the water tap frozen? Is the water supply shot off? Is there any foreign matter blocking up the inlet hose filter?
<ul style="list-style-type: none"> The washer will not drain <p>Error display OE</p>	<ul style="list-style-type: none"> Is the drain hose frozen or blocked up by dirt? Is the drain hose kinked or deformed? Is the end of the drain hose immersed in water? Is there excessive dirt inside the drain filter?
<ul style="list-style-type: none"> The washer will not spin <p>Error display UE</p>	<ul style="list-style-type: none"> Is the clothes in the drum collected on one side? Is the washer installed on an uneven floor or is the vibration serious? Is the door open? (The lamp "LE" will light up in this case.)
<ul style="list-style-type: none"> The washer will stop during spinning . Spinning is insufficient. <p>Error display PFE</p>	<ul style="list-style-type: none"> Is the filter of the drain pump clogged? Is the drain pump operated? Did you use the proper amount of detergent? Is the drain hose placed higher than 1m above floor?
<ul style="list-style-type: none"> Vibrating and too noisy 	<ul style="list-style-type: none"> Is the washer installed on an uneven floor? Have all the transit bolts removed?

These cases are not malfunctions;

- The sound "wing" heard during water supply is the operating sound made by the water inlet valve.

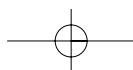

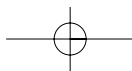

SPECIFICATION

MODEL	DWD-F1011/F1012/F1013	DWD-F1211/F1212/F1213
Dimension (mm)	595 x 540 x 850 (WxHxD)	
Maximum mass of textile (kg)	6.0	
Unit Weight (kg)	64(Net) / 68(Gross)	
Standard Water Consumption	50 l	
Spin Speed (RPM)	No Spin/400/800/1000	No Spin/400/800/1200
Operating Water Pressure	0.03MPa ~ 0.8MPa (0.3kgf/cm ² ~ 8kgf/cm ²)	

WIRING DIAGRAM

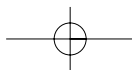
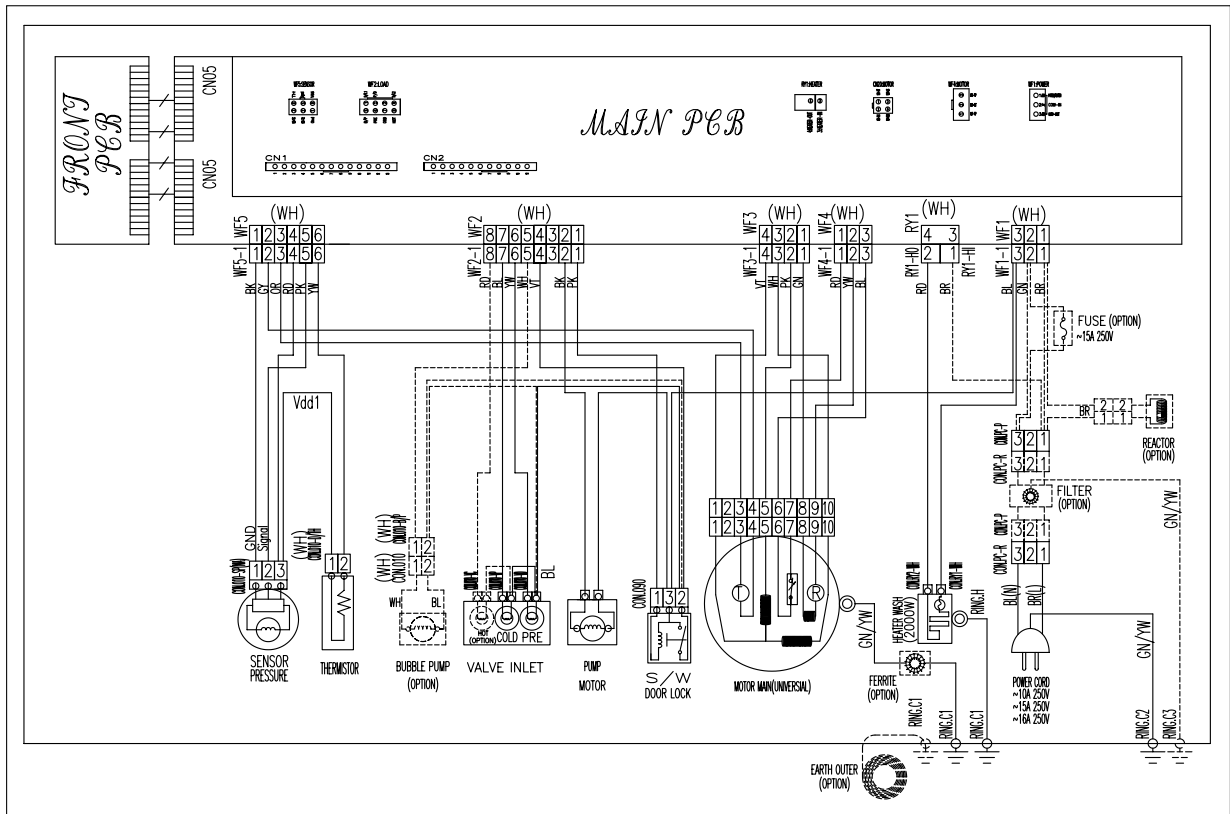

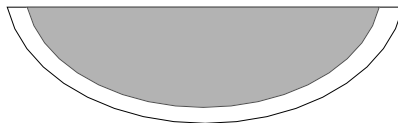
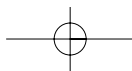

ABOUT THIS MANUAL

VISION CREATIVE, INC.

6

4

		TEL
MODEL	DWD - F1011N/1012N/1013N/1211N/1212N/1213N S	
BUYER	() - BASIC_DWD - F1011/1012/1013/1211/1212/1213 S	
	1	6
	2	7
	3	8
	4	9
	5	10
	05.03.04(Han)/06.4.17(Han)	
<p>MEMO</p> <p>2005.01.13 - 2005.01.18 - ~15p 2005.01.21 - ,9,10,11p (가 - 12~18p) 2005.01.26 - ,6,7,8,9,12,13,14,15,16,17,18,23p</p> <p>2005.01.27 -9p 2005.02.04 - 7p 2005.02.18 - 23p 2005.02.24 - 4,5p 2005.02.25 - 9p 2005.03.02 - 23p 2005.03.08 - 23p 2005.03.11 - 23p 2005.03.29 - 23p() 2005.03.30 - 가 (eps)</p> <p>2005.03.31 - (BASIC) - 9,12,13,14,15,16,17,18 - 8page</p> <p>2005.04.04 - 15,16,17,18 - 2005.04.14 -</p> <p>06.2.15 - DWD - F's(6&7kg):22 (4)</p> <p>06.3.7 - 9,18,20_ 06.3.27 - 9p_The Child Lock will be cancelled-when power is off.</p> <p>06.3.27 - 8p_ 06.4.17 - 9p - , 23p -</p> <p>06.9.26 - (spanner)_2,4,7_ ()</p>		

VISION

TEL: 730 - 0660 FAX: 730 - 3788

